



VCU

Virginia Commonwealth University
VCU Scholars Compass

Theses and Dissertations

Graduate School

2014

ATM, BRCA1, and Aurora A: Mechanisms of G2/M Checkpoint Control in Human Embryonic Stem Cells

Jason Beckta
Virginia Commonwealth University

Follow this and additional works at: <https://scholarscompass.vcu.edu/etd>



Part of the [Biochemistry Commons](#)

© The Author

Downloaded from

<https://scholarscompass.vcu.edu/etd/3477>

This Dissertation is brought to you for free and open access by the Graduate School at VCU Scholars Compass. It has been accepted for inclusion in Theses and Dissertations by an authorized administrator of VCU Scholars Compass. For more information, please contact libcompass@vcu.edu.

© Jason Mark Beckta 2013

All Rights Reserved

ATM, BRCA1, AND AURORA A: MECHANISMS OF G2/M CHECKPOINT CONTROL
IN HUMAN EMBRYONIC STEM CELLS

A dissertation submitted in partial fulfillment of the
requirements for the degree of Doctor of Philosophy in
Biochemistry and Molecular Biology at Virginia Commonwealth
University.

By

JASON MARK BECKTA
Bachelor of Science, Keene State College, 2008

Director: KRISTOFFER VALERIE
PROFESSOR, DEPARTMENT OF RADIATION ONCOLOGY

Virginia Commonwealth University
Richmond, Virginia
October, 2013

Acknowledgements

The work and writing of this dissertation was performed in the Department of Radiation Oncology at the Virginia Commonwealth University School of Medicine. I am grateful to the National Cancer Institute for believing in my potential as a scientist strongly enough to grant me a Fellowship for this project. I would like to thank all of the members of the Valerie lab whom I have had the pleasure of working with for the past several years. In particular, I would like to thank Bret Adams, Sarah Golding, and Amy Hawkins for providing the fundamental laboratory training which has served as the basis from which I was able to accomplish all subsequent work. Additionally, I would like to express my gratitude to Beth Rosenberg for her continued support, advice, and friendship. A special thanks to my committee members for their guidance and willingness to read this document. Obviously, none of this would have been possible without Dr. Valerie's mentorship. I credit the vast majority of my development, both personally and professionally, to the time I have spent under his tutelage.

There are an innumerable cast of characters in my life that have helped me get to this point - Dr. Susan Whittemore and the biology faculty at Keene State College (who were instrumental in

my acceptance to several M.D.-Ph.D. programs), Dr. Gordon Archer (for believing that I would actually contribute as a student in this program), Sandra Sorrell (because I know who really runs the show), Julie Farnsworth (for her expertise in flow cytometry, as well as property management), Dr. Scott Henderson and Frances White (who have saved my confocal experiments more times than I can count), and Dr. Tomasz Kordula (for preventing me from feeling too good about myself). A tremendous amount of thanks is owed to my parents, who have provided me with continuous love and support since before I could form memories. Finally, I am deeply appreciative to my wife, Julie. She has been the cornerstone of my sanity since we moved to Virginia, and our relationship is more valuable to me than I could possibly express.

Table of Contents

	Page
Acknowledgements	iv
List of Tables	x
List of Figures	xi
List of Abbreviations	xiv
Abstract	xvi
Chapter	
1 Introduction to Embryonic Stem Cells	1
Embryonic Stem Cells	2
Controversy Over Public Funding	10
Induced Pluripotent Cells	12
Genomic Instability	19
2 Cell Cycle Control in Human Embryonic Stem Cells ...	26
Introduction	27
G1 and the G1/S Checkpoint	29
S phase and the intra-S Checkpoint	35
G2 and the G2/M Checkpoint	41
The Decatenation Checkpoint	48
Proteins Involved in Checkpoint Signaling	52
Ataxia Telangiectasia Mutated	53
BRCA1	60
Aurora A kinase	68

3	Modulation of ATM Function	76
	Introduction	77
	Materials and Methods	81
	Antibodies, reagents, and irradiation.....	81
	Cell culture.....	81
	Western blotting.....	82
	Metaphase spreads/pseudomitotic index.....	82
	Flow cytometry.....	83
	Confocal imaging.....	84
	Live-cell imaging.....	84
	Statistics.....	85
	Results	86
	ATM is present and active in hESCs.....	86
	Catalytic inhibition of TopoII activates ATM..	89
	Inhibition of ATM abrogates G2/M checkpoints..	92
	Inhibition of ATM increases mitotic entry.....	95
	Inhibition of ATM decreases decatenation checkpoint efficiency.....	95
	Inhibition of ATM increases the time it takes to complete mitosis.....	97
	Inhibition of ATM causes tetraploid cell formation	99
	Inhibition of ATM causes aneuploidy.....	103
	Chapter Summary	105

4	ATM, BRCA1, and Aurora A: How to Arrest a Cell ...	109
	Introduction	110
	Materials and Methods	113
	Antibodies, reagents, and irradiation.....	113
	Cell culture.....	113
	Western blotting.....	114
	Confocal imaging.....	114
	Transfection (plasmid creation).....	114
	Transfection (procedure).....	115
	Immunoprecipitation.....	115
	λ -phosphatase assay.....	116
	Statistics.....	116
	Results	117
	ATM phosphorylates BRCA1.....	117
	BRCA1 and Aurora A co-localize.....	120
	Activation of ATM blocks the interaction of BRCA1 and Aurora A.....	122
	IR decreases Aurora A-mediated phosphorylation of S308-BRCA1. Concurrent inhibition of ATM reverses this effect.....	124
	Expression of a non-phosphorylatable BRCA1 mutant mimics the ATM-inhibited phenotype.....	125
	Chapter Summary	130

5	Conclusions	135
	Future Directions	143
	References	146
	Vita	171

List of Tables

	Page
Table 1.1: Major differences between mouse and primate embryonic stem cells propagated <i>in vitro</i>	8
Table 1.2: Clinical Trials using pluripotent stem cells...	25

List of Figures

	Page
Figure 1.1: Pluripotent cells are derived from the inner cell mass of the pre-implantation blastocyst.....	3
Figure 1.2: The development of aneuploid cells.....	20
Figure 2.1: Hypothesized decatenation checkpoint signaling pathway.....	49
Figure 2.2: ATM kinase functional domains and key post-translational modifications.....	55
Figure 2.3: BRCA1 functional domains and select binding partners	61
Figure 2.4: Overview of select Aurora A kinase functions..	71
Figure 3.1: Verification of pluripotency through SSEA-4 immunocytochemistry.....	87
Figure 3.2: ATM is present and active in hESCs. KU-60019 inhibits ATM activation in response to irradiation.....	88
Figure 3.3: Catalytic inhibition of topoisomerase II activates ATM, most significantly in S and G2. KU-60019 inhibits ATM activation.....	90
Figure 3.4: Catalytic inhibition of topoisomerase II arrests hESCs in G2.....	91
Figure 3.5: Inhibition of ATM abrogates the decatenation checkpoint.....	93

Figure 3.6: Inhibition of ATM abrogates the G2/M DNA Damage Checkpoint.....	94
Figure 3.7: Inhibition of ATM abrogates the decatenation checkpoint and increases the mitotic entry rate.....	96
Figure 3.8: Inhibition of ATM significantly increases the pseudomitotic index.....	98
Figure 3.9: Inhibition of ATM slows the progression through mitosis.....	100
Figure 3.10: Inhibition of ATM causes tetraploid cell formation	102
Figure 3.11: Inhibition of ATM causes aneuploidy.....	104
Figure 4.1: ATM phosphorylates BRCA1 in response to DNA damage	118
Figure 4.2: BRCA1 and Aurora A co-localize during mitosis... ..	121
Figure 4.3: Activation of ATM blocks the interaction of BRCA1 and Aurora A. Treatment with KU-60019 reverses this effect	123
Figure 4.4: IR decreases Aurora A-mediated phosphorylation of S308-BRCA1. Concurrent inhibition of ATM reverses this effect	126
Figure 4.5: Schematic of WT and 4P BRCA1 constructs	127
Figure 4.6: Expression of a non-phosphorylatable BRCA1 mutant mimics the ATM-inhibited phenotype.....	129

Figure 5.1: ATM's hypothesized regulation of the BRCA1/Aurora A interaction and activation of G2/M arrest.....138

List of Abbreviations

A-T	Ataxia telangiectasia
ATM	Ataxia telangiectasia mutated
DAPI	4',6-diamidino-2-phenylindole
DNA	deoxyribonucleic acid
ATMi	KU-60019
DSB	Double-strand break
ES	Embryonic stem
FACS	fluorescent activated cell sorting
Gy	Gray
HERP	Human Embryo Research Panel
hESC	Human embryonic stem cell
ICC	Immunocytochemistry
ICM	Inner cell mass
iPS	Induced pluripotent stem
IR	Ionizing radiation
kDa	Kilodalton
Lif	Leukemia inhibitory factor
mESC	Mouse embryonic stem cell
NIH	National Institutes of Health
PBS	Phosphate-buffered saline

PI	Propidium iodide
PVDF	polyvinylidene difluoride
SDS	sodium dodecyl sulfate
SDS-PAGE	SDS-polyacrylamide gel electrophoresis

Abstract

**ATM, BRCA1, and Aurora A: Mechanisms of G2/M Checkpoint Control
in Human Embryonic Stem Cells**

Jason Mark Beckta

A Dissertation submitted in partial fulfillment of the
requirements for the degree of Doctor of Philosophy at Virginia
Commonwealth University.

Virginia Commonwealth University, 2013

Major Director: Kristoffer Valerie

Professor, Department of Radiation Oncology

When cultured *in vitro*, human embryonic stem cells (hESCs) acquire genetic abnormalities that have slowed their therapeutic use. As hESCs have a “leaky” G1/S boundary, the pressure of ensuring genetic integrity falls on the G2/M checkpoint, which can be activated by failed chromosomal decatenation (among other stimuli). It is hypothesized that hESCs have a deficient decatenation checkpoint, but little data supports this. Evidence suggests that the ataxia telangiectasia mutated (ATM) kinase controls the G2/M decatenation and DNA damage checkpoints, though previous reports are conflicting on this point. My work demonstrates that inhibition of decatenation activates ATM and arrests hESCs in G2. Pharmacologic inhibition of ATM (ATMi) abrogates this arrest, allowing hESCs to enter mitosis. Live cell imaging studies reveal that ATMi increases the time it takes to complete mitosis. Culture of cells under ATMi causes a gain of DNA content, which is reversed once ATMi is relieved. BRCA1, a known target of ATM, is also involved in the G2/M checkpoint. Experimental evidence reveals that activated ATM phosphorylates BRCA1, preventing Aurora A from interacting with and phosphorylating BRCA1 on S308, a modification necessary for mitotic entry. Together, this data illuminates a novel pathway by which ATM activation mediates G2 arrest in hESCs.

Chapter 1:

Introduction to Embryonic Stem Cells

"Progress in basic developmental is now extremely rapid; human embryonic stem cells will link this progress even more closely to the prevention and treatment of human disease."

- James A. Thomson

Embryonic stem (ES) cells, derived from the inner cell mass (ICM) of a pre-implantation blastocyst, promise advances in developmental biology, drug discovery, and regenerative medicine that other cell lines cannot. Proposed breakthroughs come from the stem cell's defining property: pluripotency, or the ability to differentiate and form all three germ layers of the human body - the endoderm, mesoderm, and ectoderm (**Figure 1.1**). This differentiation down specific lineages takes place through symmetric or asymmetric division. Symmetric division generates a virtually unlimited supply of pluripotent cells, whereas asymmetric division produces one pluripotent cell and one differentiated cell. ES cells, first isolated from standard laboratory animals and later, from humans, have been a source of much controversy and debate. While their scientific potential is widely acknowledged, practical therapies have yet to develop. Though politics and public opinion have played a part, there are significant hurdles to overcome in the laboratory before novel treatments can be brought to the clinic.

Much of the work done on human embryonic stem cells (hESCs) has been based on studies done in mouse embryonic stem cells (mESCs). For years, the major method for isolating cells from the ICM of mouse blastocysts involved complicated and time-consuming microsurgical methods. In 1975, Solter and Knowles,

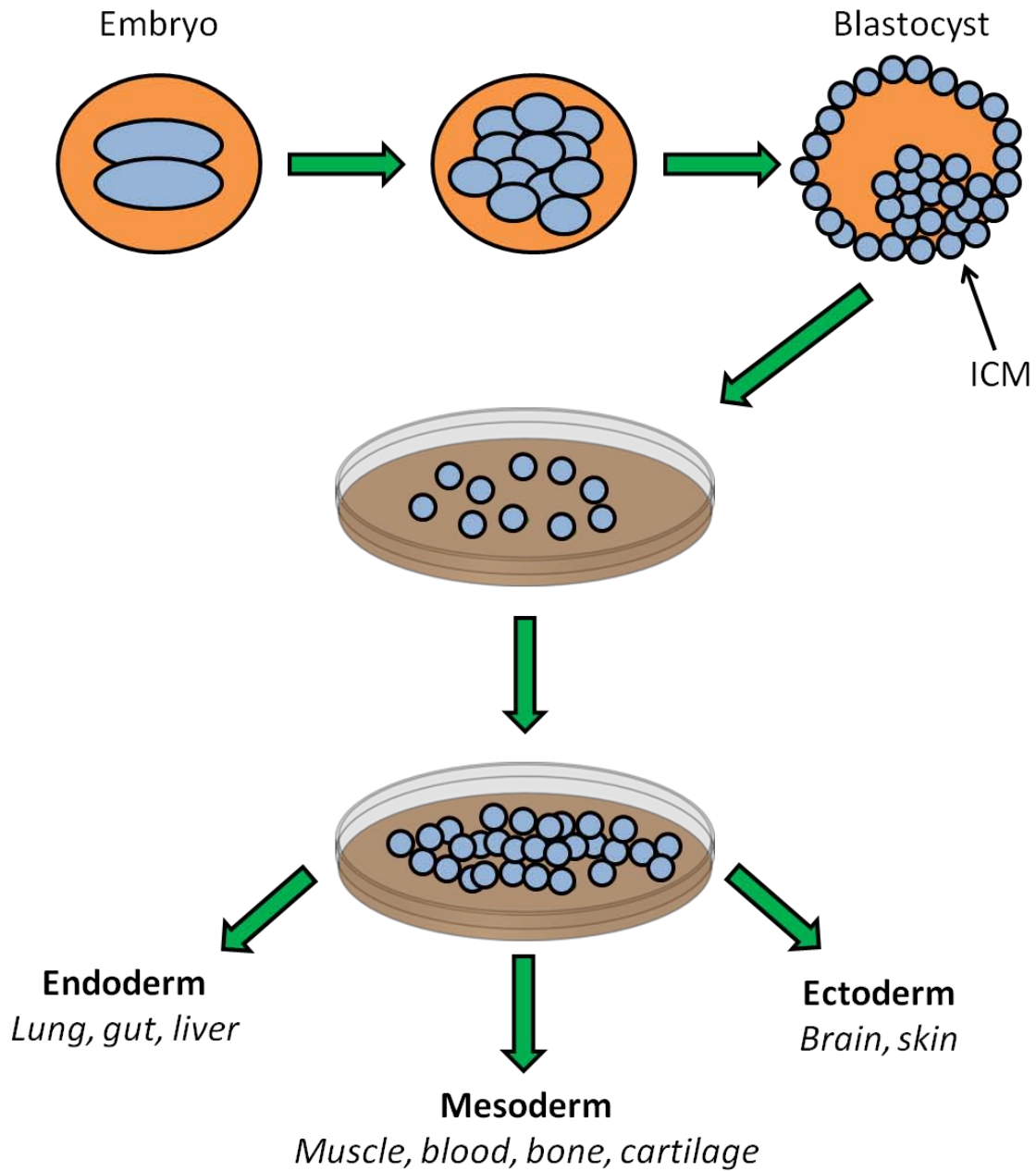

Figure 1.1 – Pluripotent stem cells are derived from the inner cell mass of the pre-implantation blastocyst.

Adapted from Yabut and Bernstein, 2011.

ICM: inner cell mass

interested in studying the immunological maternal-embryonic relationship, discovered a method for large-scale collection of cells from the ICM. They isolated blastocysts by flushing them from the uterine horns on the fourth day of pregnancy, chemically removing the zonae pellucidae, exposing the blastocysts to specialized anti-serum and complement, then removing the damaged trophoblastic layer by pipetting the blastocysts through a small-bore glass pipette (Solter and Knowles, 1975). After isolating the ICM, they plated the cells and described their appearance as such:

"Inner cell masses plated in plastic dishes developed along two morphological routes: approximately half attached to the surface and from them relatively large polygonal cells with small vacuoles began to grow. Outgrowth of trophoblastic cells was never observed. The central mass of cells then either continued to grow as a solid mass and eventually developed into a structure resembling a 7-day-old mouse embryo, or it spread and formed a monolayer composed of several cell types. Half of the inner cell masses did not attach but continued to grow, floating in the medium, forming embryoid bodies with a clearly visible outer cell layer and a solid mass of cells inside."

These descriptions are characteristic of pluripotent stem cells, though no such statements were made. The authors conclude their study by asserting that their technique is an effective method for the isolation of large numbers of ICM's (Solter and Knowles, 1975), thus setting the stage for future work in stem cell research. However, it would still be several years before pluripotent cells would be successfully propagated *in vitro*.

The first report of establishing a line of pluripotent cells from mouse blastocysts was published in 1981 (Evans and Kaufman, 1981). There had been several previous attempts to establish a stable cell line (Atienza-Samols and Sherman, 1978; Cole and Paul, 2008; Sherman, 1975; Solter and Knowles, 1975), but none were successful. It was hypothesized that sustained, successful culture of pluripotent cells would depend on three factors: 1) pluripotent cells exist in an embryo which could be propagated *in vitro*, 2) it is possible to harvest these cells from the embryo, and 3) tissue culture conditions could be developed to encourage expansion, not differentiation of pluripotent cells (Evans and Kaufman, 1981). To support their hypothesis, researchers harvested blastocysts from mice and cultured them in groups of approximately six embryos for four days. The blastocysts attached to the dish within 48 hours, and the ICM developed into "large egg cylinder-like structures", which were

picked, dispersed with trypsin, and passaged onto Petri dishes coated with mitomycin C-inactivated STO fibroblasts (Evans and Kaufman, 1981). The isolated and expanded cells were found to have a normal karyotype and key traits of pluripotent cells, and were able to survive ~30 passages (at the time of publication) (Evans and Kaufman, 1981). The successful acquisition and expansion of a stable mESC line set the stage for over two decades of work before the first non-human primate embryonic stem cells were derived.

While the isolation and *ex vivo* expansion of mESCs represented a major step forward and catalyzed an avalanche of groundbreaking research, there are enough differences between human and mouse embryonic development that scientists wondered if the conclusions drawn from mESC research would accurately reflect the processes that occurs in humans. After all, the overall goal was (and is) to use this type of cell in regenerative medicine. If novel therapies were to develop, then a more appropriate model needed to be established. To that end, James Thomson, working out of the University of Wisconsin, set out to create embryonic stem cells using an organism which more closely resembled a human: the rhesus monkey. Using the antiserum/complement technique developed twenty years before (Solter and Knowles, 1975), Thomson and colleagues successfully

isolated and expanded primate embryonic stem cells (Thomson et al., 1995). As hypothesized, there were several major differences between these cells and mESCs (see **Table 1.1** for a summary of these differences). The differences in the fundamental biology of stem cells were significant enough that the authors concluded that for embryonic stem cells to have a future in regenerative medicine, primate or, ideally, human embryonic stem cells would need to be used (Thomson et al., 1995). In fact, the year before had seen a paper published where ICM-derived cells from spare *in vitro* fertilization human embryos were isolated and cultured. However, while pluripotent cells were detected, they did not survive beyond two passages (Bongso et al., 1994). It was clear that the field of embryonic stem cell research was moving into humans, and it would be the Thomson group that would eventually take it there.

The first description of the isolation and culture of hESCs was published in 1998. Thomson and his colleagues collected fresh or frozen cleavage stage embryos which were produced by *in vitro* fertilization for clinical purposes (Thomson et al., 1998). Importantly, they achieved informed consent from both the donors and their University's Institutional Review Board. Using the same technique which was developed to isolate pluripotent cells from rhesus monkeys, Thomson's group ultimately isolated 14

	Mouse	Primate	Notes
Chromosome Number	38 autosomes + 2 sex chromosomes	44 autosomes + 2 sex chromosomes	
Supplemental LIF	Required to maintain pluripotency	Not required	
Genome expression timing	Mid two-cell stage of embryo	Between four- and eight-cell stage of embryo	Embryo relies on maternally inherited information prior to these stages
Colony Morphology	Compact, piled-up colonies with indistinct borders	Flat colonies with individual, distinct cells	Both have high nuclear:cytoplasmic ratio
Developmental Stage at time of isolation	Limited ability to contribute to trophoblastic layers in chimeras	Displays ability form trophoectoderm	Primate stem cells could be closer to totipotent stage/totipotent stage could last longer
Key expression markers of pluripotency	SSEA-1	SSEA-3, SSEA-4, TRA-1-60, TRA-1-81	

Table 1. 1 – Major differences between mouse and primate embryonic stem cells propagated *in vitro*.

Adapted from Thomson *et al.*, 1995 and Braude *et al.*, 1988.

LIF: leukemia inhibitory factor

human ICMs and derived from five embryonic stem cell lines originating from five separate embryos. Importantly, these newly derived hESCs expressed high levels of telomerase, the enzyme responsible for producing telomeres (Thomson et al., 1998). Telomeres are short, repetitive stretches of DNA composed of the nucleotide sequence TTAGGG, which function to preserve the structural integrity of each chromosomal end (Hall and Giaccia, 2012). Telomeres act as a "capping mechanism", ensuring that the ends of each chromosome are not inappropriately chewed back by exonucleases, thus distinguishing the ends from double-strand breaks (which the cell would attempt to repair) (Lundblad, 2000). As somatic cells divide, each successive division results in marginally shortened telomeres. Once the telomeres reach a critical length, growth stops and cells either become senescent or die (Hall and Giaccia, 2012). The expression of telomerase in hESCs effectively renders them immortal, adding to their allure for use in medical research. These newly described hESCs were remarkably similar to the primate embryonic stem cells, and showed similar contrasts to mESCs (see **Table 1.1**) (Thomson et al., 1998). The successful creation of hESC lines promised rapid advancement for our understanding of a variety of diseases, however, a myriad of ethical and political controversies would surround these cells and significantly limit their use for the next decade.

The controversy over public funding for embryonic research

The ethical debate over the use of human reproductive tissues for medical research has been ongoing since the late 1970s, when it became clear that biomedical science was entering an era where these tissues could, and would, be used routinely in the laboratory setting (Gottweis, 2010). This debate eventually resulted in an outright ban on government support for any form of fetal research from 1988-1993 (Wertz, 2002). However, private funding was still allowed, creating an odd environment in which controversial research could take place, virtually unregulated in the private sector, but publically funded research was effectively rendered illegal. This ban was lifted by President Clinton in 1993, which resulted in the National Institutes of Health (NIH) forming the Human Embryo Research Panel (HERP), a division responsible for creating guidelines mandating appropriate and inappropriate areas of embryonic research (Tauer, 1997). While HERP decided that it was acceptable to conduct research on "leftover" embryos from *in vitro* fertilization, Congress, via the Department of Health and Human Services appropriations process, decreed that "any activity involving the creation of, destruction of, or exposure to risk of injury or death to human embryos for research purposes may

not be supported with federal funds" (Gottweis, 2010). While public funds were now freed up to sponsor stem cell research, support was still coming solely from the private sector until the end of 1999, chiefly from the Geron Corporation and Advanced Cell Technology (Annas et al., 1999). In late 2000, the NIH published guidelines for stem cell research, and almost a year later, President Bush laid out a governmental policy which permitted public funding for hESC research using only pre-existing cell lines (which were derived using private funds) (stemcells.nih.gov/policy/pages/2001policy.aspx). In early 2009, President Obama significantly expanded the scope of cell lines which could be supported by public funds with the Executive order "Removing Barriers to Responsible Scientific Research Involving Human Stem Cells" (stemcells.nih.gov/policy/pages/2009guidelines.aspx). The effectiveness of this expansion was short lived, however, when a U.S. district court issued a preliminary injunction banning the use of federal funding for hESC research in 2010. This ruling was temporarily put on hold by the U.S. Court of Appeals, and it was eventually overturned in 2011 (stemcells.nih.gov/staticresources/Sherley_Mem_Op_granting-Defs-Mot-Summ-J.pdf). While hESC research has currently been allowed to continue, a more comprehensive and cohesive policy is clearly needed to streamline the process of hESC research in the U.S.

Induced Pluripotent Cells: A Novel Compromise

hESC research presents an interesting quandary - on one hand, the cells present an almost limitless opportunity for scientific advancement. On the other hand, the major legal and ethical controversies surrounding them have significantly limited progress towards any biomedical breakthroughs. To this end, researchers have been attempting to find a work-around for creating pluripotent cells from sources other than human embryos. This has two major advantages: 1) the use of human embryos can be avoided and 2) potential histo-compatibility problems can be solved (e.g. "growing" a new pancreas for a diabetic patient, only to have it rejected because the ES cells used had the wrong antigenic markers).

Investigators have been experimenting with cellular reprogramming for decades. The first success came in 1952 when researchers demonstrated that taking nuclei from blastula-stage embryos and transplanting them into enucleated frog eggs resulted in normal, hatched tadpoles (Briggs and King, 1952). This "nuclear transfer" method would be used extensively and eventually result in the successful somatic cloning of many different species (the most notable of which was "Dolly" the sheep) (Wilmut et al., 1997). However, this technique is still

limited in humans by the requirement for oocytes, thus not completely circumventing the issue of the use of reproductive tissues.

Another method for cellular reprogramming is the fusion of ES cells with differentiated cells, somehow forcing the somatic cells back through to a pluripotent stage. This process has been demonstrated in both mice (Tada et al., 2001) and humans (Cowan et al., 2005). However, the molecular mechanisms behind this process are not fully understood, and it has not yet been clarified if these fusion-transformed cells are 100% pluripotent (Yamanaka, 2007).

An interesting (if little studied) method developed for this process is spontaneous reprogramming by culture. For example, it has been shown that long-term culture of bone marrow-derived cells can induce pluripotency (Jiang et al., 2002), as well as the prolonged culture of germline stem cells from mouse testes (Kanatsu-Shinohara et al., 2004). Strongly limiting this technique is supporting evidence for the generality, reproducibility, and yield of pluripotent cells. Additionally, relying on long-term culture to produce pluripotent cells in any quantity sufficient enough for regenerative medicine is a prohibitive barrier.

The most recent, and most promising, development for the creation of reprogrammed somatic cells is the four-factor transformation method developed by Takahashi and Yamanaka in 2006. These de-differentiated cells were termed induced pluripotent stem (iPS) cells. Yamanaka's group identified twenty-four transcription factors which, when transduced into mouse fibroblasts, resulted in the creation of (albeit rarely) colonies of pluripotent cells. Through trial-and-error they narrowed down the twenty-four transcription factors into four: Oct3/4, Sox2, Klf4, and c-Myc (Takahashi and Yamanaka, 2006). The next year, both Yamanaka and another laboratory used the same technique to create human iPS cells (Takahashi et al., 2007; Yu et al., 2007).

In his 2007 review, Shinya Yamanaka proposed a model by which these four key transcription factors work together to promote pluripotency. c-Myc overexpression, in isolation, can cause p53-dependent apoptosis in primary cells. However, KLF4 expression can suppress p53, thereby preventing cell death. On the other hand, KLF4 can activate p21, which suppresses cell proliferation, and c-Myc in turn suppresses p21. The cell needs to strike a balance between the expression and interaction between c-Myc and KLF4 in order to remain viable. Additionally,

c-Myc can "loosen" the chromatin architecture, potentially opening up promoters for other genes/proteins important in pluripotency (Meshorer et al., 2006). However, just expressing c-Myc and KLF4 would direct cells towards a cancerous fate, not an embryonic stem cell phenotype. Oct-3/4 and Sox2 likely come into play here, activating multiple genes important for pluripotency (and not malignancy). Yamanaka hypothesizes that the c-Myc-mediated opening of chromatin facilitates Oct-3/4's and Sox2's ability to activate the appropriate genes (Yamanaka, 2007). The balance of factors required for pluripotency appears both elegant and delicate, and much work remains to be done in this area to enhance our understanding.

Since this groundbreaking work, several other methods have been developed based around the four key transcription factors. This work was spurred on by concern over Yamanaka's use of retroviral transduction, causing permanent genomic alteration. The retroviral integration can lead to tumor development, as well as continued expression of pluripotent factors in cells derived from iPS cells (Yu et al., 2009). The first modified transformation protocol involved using non-integrating adenoviruses transiently expressing the four key pluripotency factors (Stadtfield et al., 2008). Later, a separate group demonstrated successful transformation using purified

recombinant proteins (though this work was done in mice) (Zhou et al., 2009). Along these same lines, a third group achieved de-differentiation using synthetic mRNA, which was modified to overcome innate cellular antiviral responses (Warren et al., 2010). These so-called "RNA-induced pluripotent stem cells" were able to be efficiently directed down a new lineage, differentiating into myogenic cells (Warren et al., 2010). Though still in its infancy, this work promises to bring the advantages of iPS cells without the limitations of using integrating retroviruses.

iPS cells hold several advantages over hESCs, beyond the ethical and immunogenicity factors. One of the most promising uses of these cells is in disease modeling. There have been several papers published describing the reprogramming of diseased cells in order to gain a greater understanding of their underlying biochemistry (see (Cherry and Daley, 2012) and (Park et al., 2008) for example). The use of iPS cells is exciting because one could theoretically create cells from both diseased and healthy individuals (within the same family), leading to the study of genetic variants that could both positively and negatively affect the development of diseases, as well as disease outcomes (Ferreira and Mostajo-Radji, 2013). The most interesting demonstration of the power of iPS cells came out of Rudolf

Jaenisch's lab in 2007. Jaenisch's group, using a mouse model of sickle-cell anemia, first harvested fibroblasts which contained the mutant hemoglobin gene. They then transformed the fibroblasts into iPS cells, corrected the mutation, differentiated the cells into blood progenitors, ablated the bone marrow in experimental mice, and transplanted the corrected progenitors into the sickle-cell mice. This process resulted in a lasting cure for the diseased mice (Hanna et al., 2007). Techniques such as this could be adapted and improved, providing similar therapies for human patients.

As with any new technology, there are several limitations to adapting iPS cells for therapeutic use. Yamanaka's original paper complains of the ultra-low frequency of transformation (Takahashi and Yamanaka, 2006), which could present a barrier to growing a large enough population for use in regenerative medicine. As mentioned earlier, some of the techniques for creating pluripotent cells involve the use of integrating retroviruses, which have tumorigenic potential. This potential is expounded upon when one of the transduced factors is c-Myc, a commonly overexpressed oncogene. Interestingly, c-Myc can be removed and pluripotency achieved with only the three other factors, but this technique is significantly slower (Wernig et al., 2008). One study also reported that transplanted autologous

iPS cells could induce a T cell-mediated immune response, where autologous ES cells could not (Zhao et al., 2011). Finally, human iPS cells have been found to frequently develop chromosomal aberrations, which could be attributed to adaptations to prolonged culturing (Mayshar et al., 2010). The acquisition of aneuploidy, and genomic instability in general, haunts traditionally derived ES cells as well. These unwanted genetic alterations have significantly affected efforts to bring pluripotent cells out of the lab and into the clinic.

Genomic Instability: An Unfortunate Hallmark of Pluripotency

The first reports of hESC studies reported a diploid, normal karyotype (Amit et al., 2000; Reubinoff et al., 2000; Thomson et al., 1998). However, it was quickly discovered that prolonged *ex vivo* culturing and expansion of ICM-derived cells caused them to become aneuploid (Draper et al., 2004). There are several theories as to how cells become aneuploid; however, the breakage-fusion-bridge model is the most widely accepted (see **Figure 1.2**). In this model, cells either experience an unrepaired double-strand break (DSB) or a telomere is degraded enough that it is sufficiently similar to a DSB. This lesion is duplicated during S-phase and the two broken chromosomes fuse, or the cell is unlucky enough to have a separate chromosome that also has an exposed end. In either case, the broken chromosomes fuse, creating a chromosome with at least two centromeres (termed a "dicentric" chromosome). Additionally, there can be a failed attempt at homologous recombination between two non-homologous chromosomes which then become stuck together. Whatever the cause, when these multi-centric ("bridged") chromosomes enter mitosis, they are ripped apart during anaphase ("breakage"), once again leaving an exposed end that can fuse with another chromosome. This cycle is then repeated (for a more extensive review, see (Morgan, 2007)).

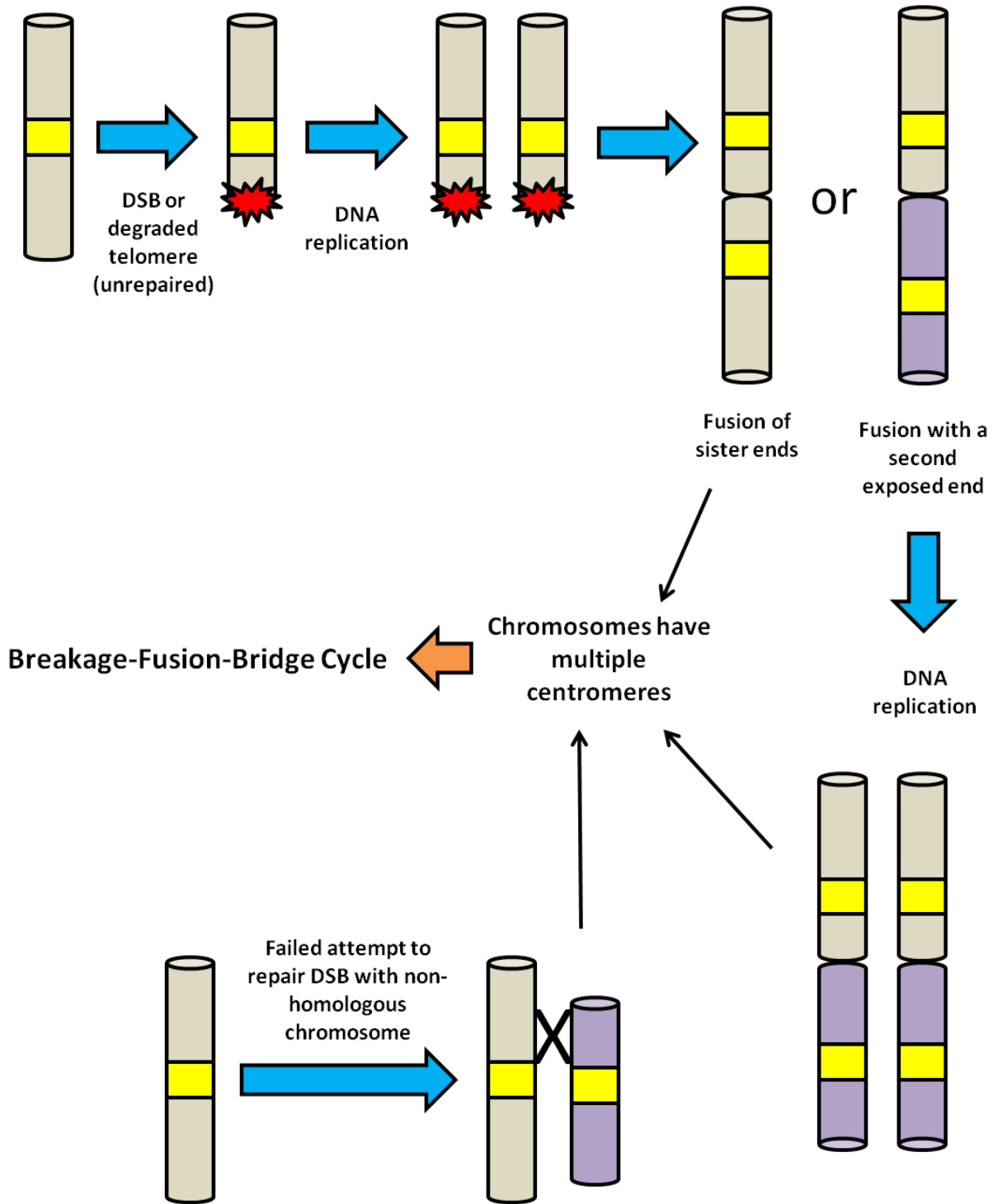

Figure 1.2 – The development of aneuploid cells.

Adapted from Morgan, 2007.

Normally, cells that experience such chromosomal aberrations will die. However, certain structural changes (and a gain or loss of certain genes) can provide a growth advantage, causing the mutant cell to eventually overtake the *in vitro* population (or, in the case of an organism, cause tumor formation).

Unfortunately, evidence suggests that both hES and iPS cells are prone to genetic abnormalities almost from the beginning. In the case of pre-implantation stage embryos, it has been estimated that as many as 30-65% of cells are already aneuploid (Wilton, 2002). In a recent study, it was found that certain lines of iPS cells became aneuploid shortly after pluripotency was established (while the parental cells were determined to be euploid) (Kim et al., 2009).

While pluripotent cells can be aneuploid from the start, it is far more common for them to develop abnormalities when cultured for a long time. This has been most extensively studied in hESCs. In 2004, a collaborative paper was published (between the University of Sheffield and the University of Wisconsin) describing hESCs which eventually (and independently) developed trisomy of chromosomes 12 and 17 (Draper et al., 2004). There are several competing (or complementary) theories as to how prolonged culture can promote the development of aneuploidy (reviewed extensively in (Baker et al., 2007)). First, and most

importantly, the technique each lab uses to culture pluripotent cells can have a major impact on whether or not genomic instability occurs. One study found that cells passaged using manual dissection (selecting and transferring colonies by deliberate choice) were able to maintain euploid karyotypes after ~105 passages, whereas bulk passaging methods (trypsin, collagenase, etc.) witnessed the development of aneuploidy after 23-45 passages (Mitalipova et al., 2005). However, since that study was published, methods have been developed to preserve a normal karyotype while bulk-passaging ES cells using enzymatic techniques (Suemori et al., 2006). Another theory of aneuploid development is the different oxygen tensions pluripotent cells experience *in vitro* vs. their *in vivo* environment. Cells in culture are kept at a significantly higher oxygen tension than what they would experience in the body, and this, in turn, has significant effects on development (see (Harvey, 2007), for example). High oxygen tension has been found to cause damage in both nuclear and mitochondrial DNA (von Zglinicki et al., 2000), and studies in hESCs have found mutations in mitochondrial DNA after prolonged culture under high oxygen conditions (Maitra et al., 2005), supporting the notion that oxygen levels influence genomic stability.

Finally, there are several additional factors which may

influence survival and karyotype preservation, but these factors are difficult to dissect out and directly study. hESCs are widely disseminated through large cell banks; the freeze-thaw cycles which these cells undergo may inadvertently select for abnormal cells which can withstand these processes best. The method of culture (beyond the question of passaging) may also select for abnormal cells with a growth advantage. Laboratories have (for the most part) transitioned from using inactivated MEF feeder layers and homemade media to artificial substrates (Matrigel) with defined, proprietary media (i.e. mTeSR-1 and-2 from Stem Cell Technologies, or StemLine from Sigma-Aldrich). These newer, xenobiotic-free and extensively studied ingredients may help alleviate the problems associated with the originally developed methods.

Pluripotent stem cells, both ICM-derived and artificially induced, harbor exceptional potential for developing therapeutic advances for many diseases. However, use of these cells has been hampered through legal and ethical quandaries, as well as the common acquisition of genetic abnormalities (e.g., aneuploidy) when expanded in the laboratory. As these abnormalities can catalyze neoplastic progression, the genomic instability inherent to *in vitro* work has slowed efforts to bring PSCs from the bench to the bedside. Though hESCs were first described

fifteen years ago, there have only been five clinical trials established (or planned) using these cells (see **Table 1.2**). Obviously, a greater understanding of the basic biology of pluripotent cells is necessary to advance their use in the clinic. Specifically, elucidating mechanisms of cell cycle control in pluripotent cells could reveal novel approaches to enhance the preservation of genomic integrity.

Country	Study	Phase	Status	Organization
USA	A Study Of Implantation Of Human Embryonic Stem Cell Derived Retinal Pigment Epithelium In Subjects With Acute Wet Age Related Macular Degeneration And Recent Rapid Vision Decline	1	Not Yet Open	Pfizer
USA	Safety and Tolerability of Sub-retinal Transplantation of Human Embryonic Stem Cell Derived Retinal Pigmented Epithelial (hESC-RPE) Cells in Patients With Stargardt's Macular Dystrophy (SMD)	1/2	Open	Advanced Cell Technology
USA	A Phase I/IIa, Open-Label, Single-Center, Prospective Study to Determine the Safety and Tolerability of Sub-retinal Transplantation of Human Embryonic Stem Cell Derived Retinal Pigmented Epithelial(MA09-hRPE) Cells in Patients With Advanced Dry Age-related Macular Degeneration(AMD)	1/2	Open	Advanced Cell Technology
USA	GRNOPC1 – Oligodendrocyte Progenitors to Address CNS Disorders (progenitors derived from hESCs)	1	Halted	Geron
Japan	Using patient-derived induced pluripotent stem cells to treat age-related macular degeneration	-	Not Yet Open	Riken Center for Developmental Biology

Table 1.2 – Clinical Trials using pluripotent stem cells.

As listed on clinicaltrials.gov, stemcells.nih.gov, and bbc.co.uk

Chapter 2:
Cell Cycle Control
in
Human Embryonic Stem Cells

Actively growing cells consist of four distinct phases: G1, S, G2, and M. Cells synthesize new DNA and separate this duplicated genetic information into two different cells; these phases are referred to as "S" and "M", respectively. The "gap" phases, G1 and G2, either produce the appropriate proteins for cells to replicate their genome (G1), or prepare the cell to divide (G2). These events and phases must be tightly orchestrated and regulated in order to ensure the appropriate growth and division of each cell. To this end, cells have evolved specific restriction points, termed "cell cycle checkpoints", which exist solely to monitor progression through the cell cycle, and allow the cell to move to the next phase if everything has occurred appropriately. If an error is detected, these checkpoints activate and growth is arrested.

While biologists have been aware of distinct phases in the life cycle of the cell for many years (i.e., (Boveri, 1902)), it wasn't until 1970 that the molecular mechanisms of cycle control began to be elucidated by Leland Hartwell (Hartwell 1970). This work was expanded upon by Paul Nurse (see (Nurse and Thuriaux, 1980) or (Nurse and Bissett, 1981) , for example) and Tim Hunt (Evans et al., 1983). Their efforts were eventually recognized in 2001, when all three investigators were awarded the Nobel Prize in Physiology or Medicine.

Once embryonic stem cells came into the scientific arena, attention was focused on their cell cycle, both out of general curiosity and practical purpose: if pluripotent stem cells commonly develop karyotypic abnormalities (despite having a lower mutational rate (Tichy, 2011)), perhaps their cell cycle checkpoints weren't as robust as their differentiated counterparts. Indeed, these cells, *in vivo*, only exist for a few days - where is the evolutionary pressure for them to have stringent cell cycle control (for perspective, see (Damelin and Bestor, 2007))? It was quickly discovered that ES cells have a common - though atypical - cell cycle structure. This structure gives us intriguing insights into the molecular mechanisms of genomic fidelity in pluripotent cells.

This chapter will be broken down into two sections. First, the three major cell cycle checkpoints (G1/S, intra-S, and G2/M) will be discussed in the context of both differentiated and pluripotent cells. Second, three major proteins will be discussed in the context of their role in cell cycle checkpoint control: ataxia-telangiectasia mutated (ATM), breast cancer gene 1 (BRCA1), and Aurora A.

G1 and the G1/S Checkpoint

The G1 phase of the cell cycle exists to produce proteins both for cellular function, as well as to prepare the cell to duplicate its DNA in S phase. In normally functioning differentiated cells, prior to commitment to entering S phase, the Rb (retinoblastoma) protein exists in a hypo-phosphorylated state (van den Heuvel and Dyson, 2008). This hypo-phosphorylated Rb binds to the E2F-DP1 transcription factors, and this complex then goes on to bind to and form a large, inhibitory complex with HDAC (van den Heuvel and Dyson, 2008). Once the cell has prepared adequately to enter S, Rb becomes phosphorylated via the kinase action of the Cyclin D-CDK4/6 and Cyclin E-CDK2 moieties, which breaks up the Rb-E2F-DP1-HDAC inhibitory complex, allowing the cells to bypass the G1/S checkpoint and enter S phase (Morgan, 2007).

If everything doesn't go according to plan, the cell can activate the G1/S checkpoint and halt growth. There are several events which can activate this first cellular barrier. If DNA damage is detected, the key phosphatase cdc25A (responsible for removing inhibitory phosphorylations on the Cyclin E-CDK2 complex) becomes ubiquitinated by the SCF ubiquitin ligase moiety (downstream of the ATM/ATR/Chk pathway, which will be

discussed further), and is thusly degraded (Morgan, 2007; Skaar and Pagano, 2009). Without cdc25A removing inhibitory phosphorylations, Cyclin E-CDK2 does not become active, and the cell cannot enter S phase. DNA damage also activates the p53 pathway, arguably the most studied protein pathway in Cancer Biology (to be discussed later in this section). Treatment with TGF- β (transforming growth factor beta), a secreted protein which controls cellular proliferation (among other functions), can also activate the G1/S checkpoint through inhibition of cdc25A transcription via its ability to enhance p21 synthesis (Hanahan and Weinberg, 2000). Finally, the checkpoint can be activated by removal of growth factors from the media. Growth factor removal activates GSK-3 β (Glycogen synthase kinase 3 beta), which in turn phosphorylates Cyclin D, leading to the cyclin's ubiquitination and proteasomal degradation (Diehl et al., 1998). Together, these events serve to ensure that the cell does not inappropriately enter the next phase of the cell cycle.

ES cells, both mouse and human, contain several distinctions from their more differentiated counterparts in regards to the G1 phase and the G1/S checkpoint. Several studies have demonstrated that ES cells have an abbreviated G1 phase (Becker et al., 2010; Filipczyk et al., 2007; Neganova et al., 2008). In mice, it was found that Rb is hyper- and constitutively-phosphorylated, which

keeps it in an inactive state (Burdon et al., 2002; Koledova et al., 2010).

In one study of hESCs, the Cyclin D-CDK4 complex was consistently up-regulated, and this was a hypothesized cause for the observed shortened G1 phase (Becker et al., 2006).

Conversely, a second group of investigators found that hESCs did not have D-type cyclins (Filipczyk et al., 2007). However, they did contain high levels of Cyclin E, another protein important for progression through G1. In opposition to these two models, other researchers have found that there are fluctuating levels of Cyclin E in hESCs, stable levels of Cyclin D, with all the appropriate CDKs present and active (Barta et al., 2013; Neganova et al., 2008). These same groups have found that CDK2, Cyclin A, Cyclin E, and cdc25A are all highly expressed in hESCs. While several labs have published contradictory results, these differences could be due to the fact that they all used different cell lines. What was universally demonstrated, however, was that ES cells are distinct from their somatic offspring.

In regards to the G1/S checkpoint, it has been repeatedly demonstrated by independent labs and investigators that both human and mouse ES cells lack an active p53-p21 pathway (Bárta

et al., 2010; Fillion et al., 2009; Momcilović et al., 2009). In normal cells, p53 is bound to another protein, MDM2 (mouse double minute 2 homolog), and kept in an inactive state (both by MDM2 transporting it to the cytosol and ubiquitinating it for proteasomal degradation (Moll and Petrenko, 2003)). In response to genotoxic events, p53 is activated through two major modifications: phosphorylation of MDM2, as well as p53 itself. MDM2 is phosphorylated by ATM on Ser395 and by c-Abl on Tyr394 (Brooks and Gu, 2010). p53 is phosphorylated by ATM, ATR, Chk1, Chk2, and DNA-PK on Ser15 and Ser20 (Brooks and Gu, 2010). These phosphorylations serve to break the inhibitory MDM2-p53 interaction, then stabilize and activate p53. Activated p53 goes on to enforce the G1/S checkpoint (among many other actions) by promoting the transcription of p21, a potent cell cycle kinase inhibitor. After translation, p21 binds to and inhibits the Cyclin-CDK2 and -CDK4 complexes, thus preventing the entrance into S phase (Sancar et al., 2004).

The p53/MDM2/p21 story is heavily studied and documented over a wide range of cell types, which makes the lack of this pathway in hESCs so interesting. For years, the non-functional p53 pathway meant that there was no known effective G1/S checkpoint in pluripotent cells. However, in 2010, Bárta and colleagues discovered that there was indeed a G1/S checkpoint in hESCs, and

that it could be activated by low-dose UV-C radiation (Bárta et al., 2010). This G1 checkpoint was not mediated by p53 activation. Instead, the extremely rapid degradation of cdc25A seemed to be the cause (Bárta et al., 2010). Interestingly, the investigators did see an increase in the levels of phospho-p53 (and p53 levels in general), which did, in turn, cause an increase in the levels of p21 mRNA. However, this increase in p21 mRNA did not lead to an increase in the p21 protein. Upon further experimentation, it was discovered that pluripotent cells were expressing miR-302s, and these micro-RNAs were preventing the translation of p21 (Dolezalova et al., 2012). In fact, it appears that the increased translation of p21 in pluripotent cells, instead of (or complementary to) enacting the G1/S checkpoint, causes differentiation of the cells. This was discovered after artificially stabilizing p53 for long periods with Nutlin (Maimets et al., 2008). It was also found that decreasing Oct4 levels (a transcription factor important for pluripotency) also increases p21 levels and thus, differentiation (Greco et al., 2007; Lee et al., 2010).

Though it was thought for many years that human and mouse ES cells did not have a G1/S checkpoint, more recent work has cast doubt onto that hypothesis. However, while stem cells can activate a G1 checkpoint through cdc25A degradation, this arrest

appears "leaky". Experiments with BrdU incorporation (and other assays) have found that damaged hESCs still enter S phase at an appreciable rate (Bárta et al., 2010; Hyka-Nouspikel et al., 2012; Lee et al., 2010; Momcilović et al., 2009). This is disquieting, as most other cell types would stringently arrest before DNA replication to prevent the propagation of genomic errors. This leaky checkpoint puts pressure on the other phases of the cell cycle to catch what it erroneously allows to pass.

S Phase and the Intra-S Checkpoint

If genomic lesions make it past the G1/S checkpoint, these insults can be replicated and turned into heritable mutations. Therefore, cells have evolved an intra-S phase checkpoint to attempt to prevent this from happening. The S phase checkpoint can be considered the last line of defense, as it functions to prevent cells from duplicating genomic errors acquired in, or before, S phase. Traditional activators of the intra-S checkpoint include replication stress, nucleotide excision repair, or resected breaks in DNA (Chen et al., 2012). The term "replication stress" usually refers to stalled replication forks. Fork progress is halted when the replication complex encounters a genetic lesion. When the fork comes to a break, one DNA polymerase enzyme will arrest while the other continues on (Smith et al., 2010).

The most heavily studied pathway controlling this checkpoint involves the ataxia-telangiectasia and Rad3-related (ATR) and Chk1 kinases. Experimental investigations have found that homozygous deletion of either the ATR or Chk1 genes results in peri-implantation embryonic lethality at embryonic day 7 (Brown and Baltimore, 2000; Garrett and Collins, 2011) for ATR and between days 3.5 - 7.5 (Takai et al., 2000) for Chk1. The only

known viable mutation of ATR in humans results in Seckel syndrome, which is characterized (as are many other disorders relating to DNA damage response protein mutations) by growth retardation and microcephaly (O'Driscoll et al., 2003).

The intra-S checkpoint, as mediated by ATR, is activated when a stalled fork causes an excessive amount of single-strand DNA formation. This single-stranded DNA is immediately coated by RPA (replication protein A), which recruits ATR to the area via the ATR-interacting protein (ATRIP), a regulatory complex which enhances ATR binding and activity (Chen et al., 2012). ATR, once recruited to the lesion, becomes activated and phosphorylates Chk1 on Serine 317 and Serine 345. Serine 345 phosphorylation is essential for Chk1 activation (Takemura et al., 2006; Wilsker et al., 2008). Once activated, Chk1 autophosphorylates on Serine 296, which leads to its dissociation from chromatin (Chen et al., 2012). Chk1 then goes on to phosphorylate and inhibit cdc25A (in the case of the intra-S checkpoint) or cdc25C (in the case of the G2/M checkpoint).

As eukaryotic DNA replication occurs throughout S phase via multiple origins of replication distributed across the genome, proper regulation of S phase involves the surveillance of both the firing of individual origins and replication fork

progression after initiation. Due to the complexity of this process, there is considerable debate in the field over exactly how the intra-S checkpoint exerts its control over the cell cycle. For the most part, it appears to be less of an absolute arrest of cell activity, and more of a delay/slowing in S-phase progression (Ge and Blow, 2010; Ge et al., 2007; Grallert and Boye, 2008). Currently, it appears that the intra-S checkpoint represses late-origin firing (Grallert and Boye, 2008), while not preventing new fork initiation at sites very close to whatever genetic defect activated the checkpoint (Labib and De Piccoli, 2011).

There has been very little study of the intra-S phase checkpoint in pluripotent cells, whether it is in mouse, human, or otherwise. This is surprising, given that ~60% of ES cells are in S phase at any given moment (Savatier et al., 2002), and, as previously discussed, these cells lack a strong G1/S checkpoint. However, one group specifically investigated the intra-S checkpoint of mESCs back in 2005. They discovered that treating cells with caffeine, a known inhibitor of both the ATM and ATR kinases, resulted in an S-phase delay and apoptosis (Jirmanova et al., 2005). Interestingly, during the course of these experiments, Jirmanova et al found that basal ATM and ATR kinase activity was relatively high. This is in direct contrast to

previous studies, where it was demonstrated that terminally differentiated cells had virtually no basal ATM/ATR activity, but treatment with irradiation caused rapid activation (Bakkenist and Kastan, 2003). To tease out which kinase was important for S-phase progression, Jirmanova and colleagues treated cells with caffeine (at a dose sufficient to inhibit ATR) or wortmanin, at a dose sufficient to inhibit ATM (but not ATR). It was found that inhibition of ATR, not ATM, was what caused the S-phase delay (Jirmanova et al., 2005). Seeking to elucidate this pathway further, they created p38 α knockout cells. A prototypical stress-activated protein kinase, p38 α is known to play a role in the cell cycle (for review, see (Duch et al., 2012)). Using these cells and caffeine, it was found that inhibition of ATR activates a p38 α -p21 pathway which triggers the intra-S checkpoint. While p21 was increased, researchers failed to find any increase in p53 levels or activity, suggesting this arrest was solely due to the ATR- p38 α interaction (Jirmanova et al., 2005).

The only study done on S-phase checkpoints using human cells was performed with embryonal carcinoma (EC) cells. The authors justified their use in lieu of, and generalized their findings to, hESCs because "EC cells have some similarities to ES cells in terms of karyotypic changes, adaptation to culture, and

teratoma formation" (Mackenzie, 2006; Wang et al., 2009). They mostly compared checkpoint response in undifferentiated vs. retinoic acid-differentiated EC cells. Wang et al found that undifferentiated cells survived better and had more efficient DNA repair after irradiation compared to their differentiated counterparts (Wang et al., 2009). Additionally, the undifferentiated EC cells showed an "enhanced" S-phase delay. By inhibiting Chk1 with the Chk1-specific inhibitor UCN-01, the S-phase checkpoint activation was abolished (Wang et al., 2009). These results support Jirmanova et al's data, indicating that, like their somatic counterparts, pluripotent cells rely on the ATR-Chk1 axis to mediate S-phase delay.

While only two studies have examined the intra-S checkpoint in pluripotent cells, it is evident that the signaling pathway used is similar to differentiated cells. However, given the amount of time that ES cells spend in S phase, it is surprising that more researchers haven't taken on projects investigating the relevant proteins working to ensure genomic integrity during DNA replication. It seems that these types of studies are technically demanding, thus limiting a researcher's ability (and motivation) to study the intra-S checkpoint. Regardless, with a weak G1/S checkpoint, and an S phase checkpoint which only delays cycle progression (instead of outright arresting it), it

stands to reason that the final checkpoint before mitosis, the G2/M checkpoint, must be robust if a cell hopes to accurately pass on its genetic information.

G2 and the G2/M Checkpoint(s)

If the G1/S or intra-S checkpoints fail to activate and prevent cells with genetic lesions from continuing to cycle, the G2/M checkpoint still stands guard against the creation of abnormal progeny. Similar to the G1/S checkpoint, the G2/M checkpoint depends on the activities of cyclins and cyclin-dependent kinases to function. At this point in the cell cycle, the chief proteins involved make up the Cyclin B/CDK1 complex. In cells that aren't ready to enter mitosis, the Wee1 and Myt1 kinases phosphorylate CDK1 and keep it in an inactive state. Once the decision has been made to divide, Aurora A (along with its cofactor, Bora) activates and phosphorylates Plk1. Once activated, Plk1, in turn, phosphorylates cdc25C. Activated cdc25C removes the inhibitory phosphorylations from Cyclin B/CDK1, and promotes the progression to mitosis (for review, see (Morgan, 2007)).

However, if the cell notices that something has gone awry in its normal growth pattern, it has several options available to arrest growth and prevent the entry into mitosis. Canonically, DNA damage will activate ATR and ATM, which will activate Chk1 and Chk2 (respectively), which will, among other actions, phosphorylate cdc25C and target it for destruction (Ciccio and

Elledge, 2010; Rieder, 2011).

There is a second, little-studied pathway for G2/M arrest involving the p38 MAP kinase. A member of the mitogen-activated protein kinase (MAPK) family, there are four isoforms of p38 (alpha and beta are universally expressed, while gamma and delta have a tissue-specific expression pattern) (Thornton and Rincon, 2009). Many different types of DNA/cellular damaging agents have been found to activate the p38 checkpoint pathway: drug treatment with microtubule inhibitors, topoisomerase II inhibitors, and histone deacetylase inhibitors; excessive illumination during microscopy experiments, and media changes (osmotic stress) (Matsusaka and Pines, 2004; Mikhailov et al., 2004, 2005, 2007; Rieder, 2011). While it is not clear exactly how p38 is activated in response to DNA damage, it has been demonstrated that ATM activation is required for p38 activation. Since there are no ATM phospho-motifs on p38, it has been hypothesized that ATM signals through the Tao kinases, which can phosphorylate p38 (Thornton and Rincon, 2009). There does appear to be some mechanism by which p38 can be activated independently of ATM, but this activation has not been well characterized (Mikhailov et al., 2004; Reinhardt et al., 2007). Once activated, it is believed that p38 phosphorylates MK2, which then goes on to phosphorylate and inactivate cdc25B, another

phosphatase important for cell progression through the G2/M checkpoint (Lemaire et al., 2006; Manke et al., 2005).

Interestingly, there is also a role for p53 in executing the G2/M checkpoint. Similar to its G1 activities, the ATR/ATM Chk1/Chk2 signaling pathway can phosphorylate and stabilize p53. As in G1, activated p53 promotes the transcription and translation of p21, which will bind to (and prevent from functioning) the Cyclin B/CDK1 complex (Abbas and Dutta, 2009). In addition to p21, p53 can also promote the function of the 14-3-3 complex. This complex will bind to the phosphorylated version of the Cyclin B/CDK1 complex and export it from the nucleus (Abbas and Dutta, 2009). Similarly, activated p53 will also promote GADD45's binding to the cyclin/CDK complex and direct those proteins to the cytoplasm (Thornton and Rincon, 2009). It is important to note, however, that studies have demonstrated that while p53 promotes the G2/M checkpoint, it is not essential (see (Löbrich and Jeggo, 2007) for discussion).

Classical studies demonstrated that the G2/M checkpoint was highly sensitive to DNA damage. Working in yeast, researchers found that a single double strand break (DSB) was sufficient to arrest cell growth (Bennett et al., 1997). This model was widely accepted to be the case for mammalian cells as well. However,

further investigation found this belief to be inaccurate. Using Artemis-deficient cells (which have a defect in repairing DNA damage, but no defect in checkpoint activation), researchers found a "critical threshold" of DSBs which cells would have to endure before checkpoint activation (Deckbar et al., 2007). This threshold was approximately 20 DSBs. Deckbar et al found that if DNA damaging agents caused fewer than 20 DSBs, the G2/M checkpoint would not activate. If these damaging agents caused more than 20 breaks, cycling would pause until the cells had repaired enough damage to get below the critical threshold (Deckbar et al., 2007). Therefore, there appeared to be a dose-dependent length of arrest - the higher the levels of damage, the longer the cells would remain arrested.

This dose-dependent length of arrest is important, because tumor cells show a sort of "adaptation" to cell cycle arrest. Was this threshold model accurate, or were cells, instead of repairing enough damage to get under the critical 20 DSB threshold, just adapting to the DNA damage and continue to grow? After all, under continuous exposure to 6 Gy of IR, tumor cells eventually break free of arrest and enter mitosis with multiple, unrepaired breaks (Bartek and Lukas, 2007; Syljuåsen et al., 2006). This adaptation appears to be mediated by the resumption of Plk1 activity and the inhibition of Chk1 (Bartek and Lukas, 2007;

Syljuåsen et al., 2006). However, what was observed in these tumor lines does not appear to be the case for somatic (non-neoplastic) cells. In the Artemis-deficient cells, which could not repair the DSBs (but were otherwise normal), cell cycle arrest continued for many days (Deckbar et al., 2007).

Unfortunately, there have been few studies conducted which directly investigate G2/M checkpoint activation in embryonic stem cells (though several groups have investigated cancer stem cell checkpoint function - this will not be discussed). One of the earliest reports looked at the Akt/Protein kinase B (PKB) pathway in mESCs. Akt is a critical protein mutated in many human cancers. It is involved in the regulation of many cellular functions including metabolism, cell growth, apoptosis and survival (for review, see (Song et al., 2005)). Using PTEN knockout mESCs, Kandel and colleagues found that they could override the G2/M checkpoint after irradiation (PTEN is a phosphatase responsible for removing activating phosphorylations from the Akt molecule) (Kandel et al., 2002). They assert that normal Akt signaling is needed for mESCs to properly transverse the G2/M checkpoint, however, they offer no pathway/mechanism for this opinion (Kandel et al., 2002).

Another set of investigators examined the effect of Rad9

knockout on mESCs. Rad9, together with Rad1 and Hus1, form the "9-1-1" complex, which functions in DNA repair and activation of cell cycle checkpoints (Doré et al., 2009; Sohn and Cho, 2009; Xu et al., 2009; Zhang et al., 2011). The 9-1-1 complex executes these actions by first being loaded onto damaged chromatin. After loading, the 9-1-1 complex binds TopBP1, which stimulates ATR-mediated Chk1 phosphorylation and downstream events (such as cell cycle arrest) (Delacroix et al., 2007). Zhang et al showed that Rad1 knockout mESCs were defective in G2/M arrest after both UV- and gamma-irradiation (Zhang et al., 2011).

Recently, the canonical DNA damage signaling pathway involving ATM/Chk2/p53 was investigated in hESCs. Using gamma radiation, Momcilovic et al demonstrated that ATM was phosphorylated and localized to sites of DSBs within 15 minutes, and that cells arrested in G2, not G1 (Momcilović et al., 2009). The peak level of ATM, Chk2, and p53 phosphorylation was seen within 1 hour of IR. Interestingly, it was observed that the cell cycle arrest was temporary - after 16 hours, the irradiated cells resumed proliferation (Momcilović et al., 2009). It was unclear whether this release was due to the hESCs repairing the damage to get below the critical threshold of DSBs, or, like tumor cells, they can eventually overcome the block even in the presence of significant damage. To confirm that ATM was responsible for

mediating arrest, Momcilovic *et al* used the ATM-specific kinase inhibitor, KU-55933, to pharmacologically inhibit ATM. Treating with KU-55933, it was observed that the G2 arrest could be abolished 2 hours after irradiation. Notably, it was observed that ATM could only be inhibited by using 10x the normal dose (10 μ M is sufficient to inhibit ATM in other cell types, here, 100 μ M was used) (Momcilović *et al.*, 2009). This is curious, as other labs have used KU-55933 to inhibit ATM in hESCs at standard dosages (Adams *et al.*, 2010a, 2010b). While the authors claim that KU-55933 at 100 μ M should still, theoretically, only inhibit ATM, it is possible that such a high concentration could inhibit other kinases involved in the DNA damage response/growth and proliferation, such as DNA-PK or mTOR (per the IC50 values provided on www.tocris.com). Further study is warranted in this area.

While there is a paucity of reports investigating the G2/M checkpoint in ES cells, it does appear that their mechanisms for arrest are similar to differentiated cells, at least insofar as arrest caused by DNA damaging agents. However, DNA damage is not the only way to cause a G2/M arrest. There is another, distinct checkpoint which takes place at the border of mitosis - the decatenation checkpoint.

The decatenation checkpoint

After replication, daughter chromatids contain areas of entanglement, or catenations. These catenanes form when two replication forks meet, and the parental and daughter strands cannot separate (Downes et al., 1994). The cell must relieve these catenations for normal replication to complete. If catenations are not resolved, a distinct G2/M cell cycle checkpoint activates - the decatenation checkpoint. If the checkpoint does not activate, nondisjunction and chromosome breakage can occur, causing genomic aberrations in daughter cells. Topoisomerase II- α is the enzyme responsible for decatenation and decatenation checkpoint signaling (Bower et al., 2010a). Topoisomerase II untangles chromosomes via the same mechanism by which it relieves helical stress after replication: by binding to DNA, cutting both strands, passing a second DNA duplex through the cut, and re-ligating the cut strands (for review, see (Wang, 2002)).

Failure to adequately decatenate chromosomes activates the decatenation checkpoint. Currently, the checkpoint signaling cascade is not well characterized. A hypothesis of the pathway is given in **Figure 2.1**. Initial studies of the checkpoint examined the proteins involved in the DNA damage response

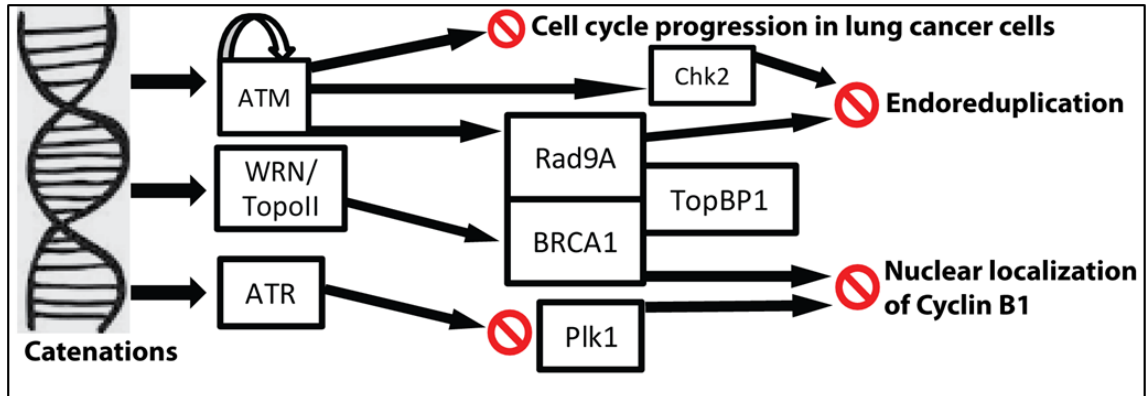

Figure 2.1 – Hypothesized decatenation checkpoint signaling pathway.

Based on all available published studies.

pathway, ATM and ATR. It was found that ATR, not ATM, mediated the checkpoint, and that BRCA1 was also involved (Deming et al., 2002). Interestingly, experimental data indicated that while ATR was essential for checkpoint activation, it wasn't acting through the traditional Chk1 pathway. Instead, it suggested that ATR mediated the decatenation checkpoint by excluding Cyclin B/CDK1 complexes from the nucleus through an unknown mechanism (Deming et al., 2002). A later study using lung cancer cell lines found that inhibiting decatenation caused autophosphorylation of ATM, but this finding was not followed up on (Nakagawa et al., 2004). Recently, studies have surfaced stating that ATM, not ATR, mediates the checkpoint (Bower et al., 2010b) (the same group that published the initial, conflicting paper on ATM/ATR and decatenation checkpoint signaling), or that ATM and ATR have complementary roles in the checkpoint (Greer Card et al., 2010).

Murine embryonic stem cells and CD34+ human hematopoietic progenitor cells were found to have a defective decatenation checkpoint (Damelin et al., 2005). This defect is hypothesized to be a cause of the chromosomal aberrations witnessed in culture (i.e., catenations are not resolved, nondisjunction occurs during mitosis, and a gain of chromosome 12 or 17 is acquired, conferring some sort of growth advantage). It is

theorized that the stem cells harvested from blastocysts and expanded *in vitro* have had little selection pressure for stringent cell cycle regulation, as their *in vivo* environment requires few divisions (Damelin and Bestor, 2007).

Unlike the G2/M DNA damage checkpoint, there have been relatively few papers published on the molecular underpinnings of the decatenation checkpoint in the nearly 20 years since it was first described, and the few papers that have been published present contradictory results. Additionally, the only paper which examined the decatenation checkpoint in ES cells proposes a tantalizing mechanism by which aneuploidy could develop in pluripotent cells. Clearly, more work needs to be done in this area to enhance our understanding of the decatenation checkpoint and how manipulation of this pathway can be used to enhance stem cell genomic integrity.

Proteins involved in checkpoint signaling

The field of study regarding our molecular understanding of cell cycle control has exploded since the groundbreaking work done in the 1970's. Thousands of manuscripts, books, and doctoral dissertations have been authored on the intricate protein signaling networks that govern the growth and genomic integrity of individual cells. The present work will focus on three proteins which are known to play key roles in checkpoint regulation: ATM, BRCA1, and Aurora A. As it is not feasible to accurately convey the current state of knowledge on each of these proteins, several references to seminal books and review papers are given in the following sections.

Ataxia Telangiectasia Mutated

Ataxia telangiectasia (Online Mendelian Inheritance in Man (OMIM) database ID: 208900) is a rare disease inherited in an autosomal recessive manner (Lavin, 2008; Perlman et al., 2012). Its pathology is characterized by progressive neurodegeneration (primarily in the cerebellum), telangiectasia (dilation of blood vessels, mainly around the mouth and eyes), immune deficiency, thymic and gonadal atrophy, a predisposition to cancer, acute sensitivity to radiation, growth retardation, premature aging, and insulin resistance (Shiloh and Ziv, 2013). Typically, affected patients express a truncated form of ATM or one plagued by missense mutations. Many of the major symptoms of ataxia telangiectasia can be attributed to a defective cellular response to endogenous, physiological DSBs or by exogenous DNA damaging agents.

The protein responsible for the disease, ATM, is a 350 kDa protein containing 3,056 amino acid residues. A serine/threonine kinase, ATM targets and phosphorylates serine-glutamine (SQ) and/or threonine-glutamine (TQ) motifs on substrate proteins. Currently, there is a distinct lack of structural information on ATM, as it has yet to be crystallized (due to the technical challenge of crystallizing this particular molecule) (see **Figure**

2.2 for a schematic of the ATM protein). ATM acts as a “transducer” of DNA damage, signaling other proteins when damage is detected. Other protein complexes bind to the lesions first (the “sensors” of DNA damage) and bring ATM in to activate a global cellular response to DNA damage (for review, see (Shiloh and Ziv, 2013)). As discussed in the previous sections, this signal transduction is crucial to G1/S and G2/M checkpoint activation.

ATM is a member of the PI3K-like protein kinase family (PIKK). Two other members of the PIKK family play key roles in the DNA damage response (DDR) and cell cycle checkpoint signaling: ATR and DNA-PK (DNA-dependent protein kinase catalytic subunit). ATR (as discussed earlier) also acts as a signal transducer, often performing overlapping functions with ATM. DNA-PK is best known for its role in non-homologous end joining (NHEJ), where it forms a holoenzyme with the KU-70/KU-80 heterodimer (Hill and Lee, 2010; Neal and Meek, 2011; Shiloh and Ziv, 2013). Interestingly, cells from ataxia telangiectasia patients are able to perform some of functions of the DDR which are known to be ATM dependent (although in a somewhat diminished capacity) (Tomimatsu et al., 2009). It is possible that some other proteins in the PIKK family (like ATR and DNA-PK) can “fill in” for ATM and take on some of the workload in its absence.

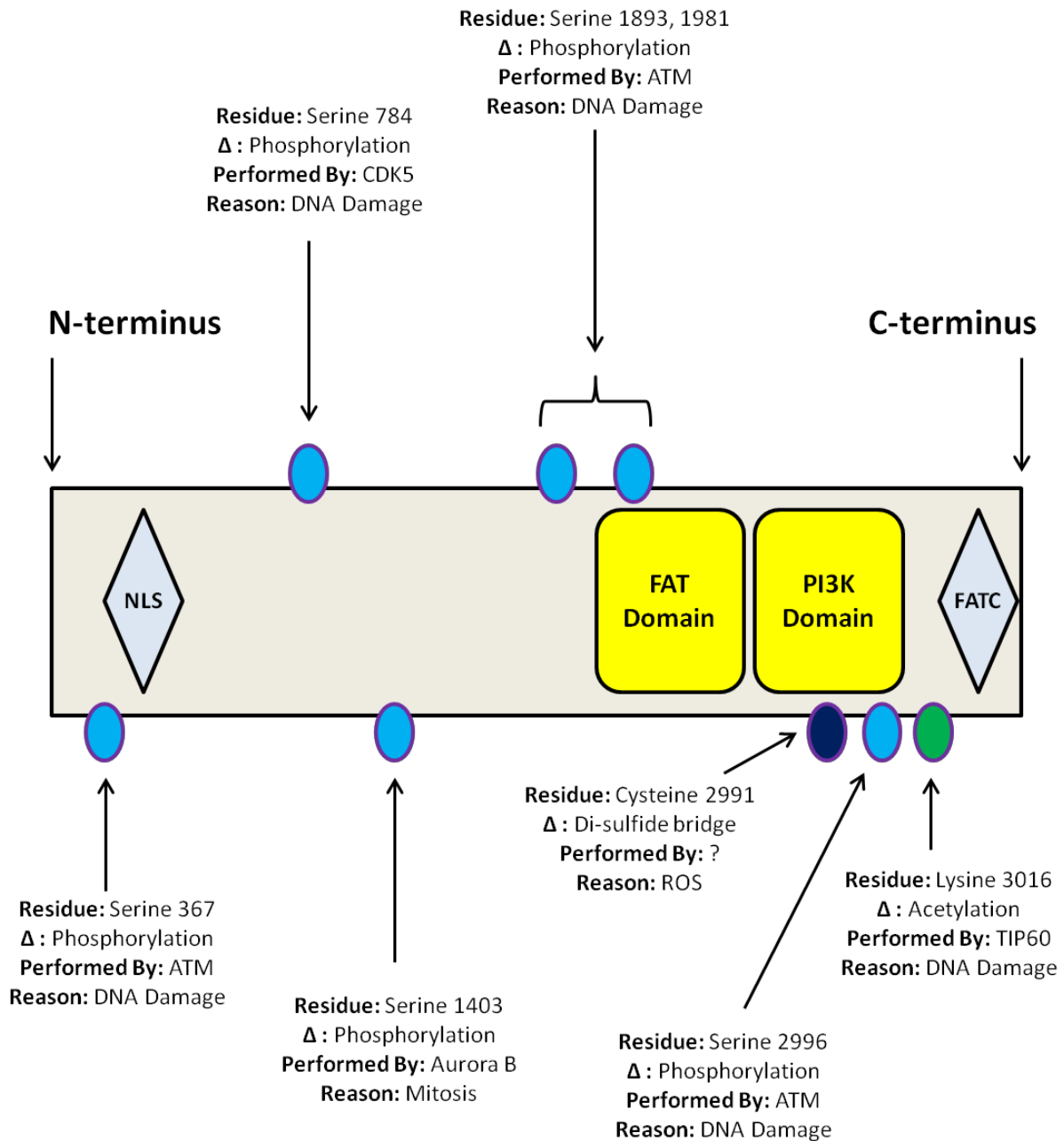

Figure 2.2 – ATM kinase functional domains and key post-translational modifications.

Adapted from Shiloh and Ziv, 2013.

NLS: nuclear localization sequence, PI3K: phosphatidylinositol 3-kinase

ROS: reactive oxygen species

While there are conflicting reports over exactly how (and what) activates ATM in response to DNA damage (or other agents - to be discussed), the most accepted model begins with the Mre11/Rad50/Nbs1 complex, commonly known as the MRN complex. The MRN complex is a highly conserved group of proteins shown to rapidly localize to sites of DNA damage and play an important role in homologous recombination repair (HRR), NHEJ, and cell cycle checkpoint signaling (see (Lavin, 2008), for review). Mre11/Rad50/Nbs1 binds to sites of DSBs and tethers the two broken ends together. This binding is crucial for the recruitment and activation of ATM. Under normal conditions, ATM exists in the cell as an inactive dimer, and, upon recruitment to sites of DSBs by the MRN complex, activates and dissociates into two monomers (Bakkenist and Kastan, 2003). During the activation sequence, ATM is autophosphorylated on Serine 367, Serine 1893, and Serine 1981 (Czornak et al., 2008) (see **Figure 2.2** for a summary of the key activating post-translational modifications of ATM). While there is conflicting information on the subject, it is currently hypothesized that ATM's autophosphorylation (specifically on Serine 1981) is not required for its monomerization or recruitment to sites of DSBs, rather, the autophosphorylation is essential for retention at sites of genetic lesions (Bensimon et al., 2010; Lee and Paull, 2005; So et al., 2009). However, a group of investigators did

find evidence supporting the notion that autophosphorylation is the cause of monomer formation (Bakkenist and Kastan, 2003).

Other evidence-based models have been brought forward suggesting that the DSB-MRN complex pathway may not tell the entirety of the story. Michael Kastan's lab published a report demonstrating that the conformational change in chromatin, which follows DSB formation, rather than the DSB itself, is what causes ATM activation (Bakkenist and Kastan, 2003). A later paper supported this model by showing that artificial "tethering" of ATM to chromatin could activate the ATM-dependent DDR (Soutoglou and Misteli, 2008). In contrast, other work has suggested that ATM needs to interact with broken DNA to become activated (You et al., 2007), and that oligonucleotides from resected DSBs have the ability to activate ATM (Jazayeri et al., 2008). It is likely, given ATM's widespread responsibilities in genomic surveillance, that most, if not all of these models contain some sort of truth. Further work is needed in this area to clarify the conditions under which ATM is activated.

Over the past several years, many novel pathways involving ATM have been described. Investigators have shown that ATM can activate NF- κ B, which promotes the transcription of anti-apoptotic genes (Hadian and Krappmann, 2011; Rashi-Elkeles et

al., 2006). It does this by phosphorylating IKK γ , a subunit of the I κ B kinase (IKK) family (McCool and Miyamoto, 2012). In unstimulated cells, the I κ B proteins inhibit NF- κ B by keeping it sequestered in the cytoplasm. Once IKK γ is phosphorylated and activated by ATM, it, in turn, phosphorylates I κ B α , which leads to I κ B ubiquitination and eventual degradation (Shiloh and Ziv, 2013). Once these inhibitory proteins are degraded, NF- κ B is free to enter the nucleus and begin transcription.

ATM is also involved in the oxidative stress response. Reactive oxygen species exert their damage by direct oxidation of cysteine residues, disrupting the structure and function of important intracellular proteins. However, the oxidation of certain cysteine residues in ATM catalyzes the formation of active, disulphide-crosslinked ATM dimers which are then able to enact a global cellular response to oxidative stress (Guo et al., 2010). Along these same lines, it has been discovered that ATM is important in the generation of the anti-oxidant cofactor, NADPH. NADPH is produced by the pentose phosphate cycle and promotes the regeneration of GSH (reduced glutathione) (Rush et al., 1985). ATM comes into play by phosphorylating heat shock protein 27 (HSP27), which binds to and stimulates the activity of glucose-6-phosphate dehydrogenase (G6PD), a key enzyme in the pentose phosphate cycle (Cosentino et al., 2011). These

oxidative stress functions of ATM are hypothesized to be one of the causes of the neuronal degeneration witnessed in ataxia telangiectasia patients. Neurons, one of the most active cell types in the body, generate a large amount of oxidative, metabolic byproducts. A lack of functional ATM means these harmful byproducts are free to cause significant damage to the cell, leading to apoptosis or necrosis.

Since the ATM gene was first identified in 1995, it has been the subject of numerous studies approaching the molecule from various angles. Currently, a PubMed search for "atm kinase" returns almost 4,000 results. These reports all provide evidence for ATM's significant role in protecting the integrity of the genome. However, recent studies have made clear that ATM's role in genetic protection does not begin and end with the DNA damage response. As more work is done with this kinase, we will begin to elucidate answers to questions we didn't even know to ask.

BRCA1

In 1994, researchers made a major breakthrough in uncovering the cause of hereditary breast cancer by discovering the "breast and ovarian cancer susceptibility gene 1", now colloquially referred to as BRCA1 (Miki et al., 1994). BRCA1 is a relatively large protein, weighing approximately 220 kDa and spanning 1863 amino acids. The N-terminus contains a RING finger domain, while the C-terminus contains two BRCT domains. The intervening sequence contains a nuclear export signal, two nuclear localization signals (Chen et al., 1996), a DNA binding domain, as well as a serine-glutamine (SQ) cluster domain (refer to **Figure 2.3** for a schematic of the BRCA1 protein, as well as important binding partners).

BRCA1's N-terminal RING domain is an E3 ubiquitin ligase and forms a complex with another RING domain-containing protein, BARD1 (Wu et al., 1996). This heterodimer has been shown to autoubiquitinate BRCA1, which, in turn, increases BRCA1's ubiquitin ligase activity (Mallery et al., 2002; Nishikawa et al., 2004; Wu-Baer et al., 2003). The BRCA1-BARD1 interaction promotes nuclear localization by masking the BRCA1 nuclear export signals, leaving the dual nuclear localization signals uncovered (Fabbro et al., 2002; Rodriguez et al., 2004). BRCA1's

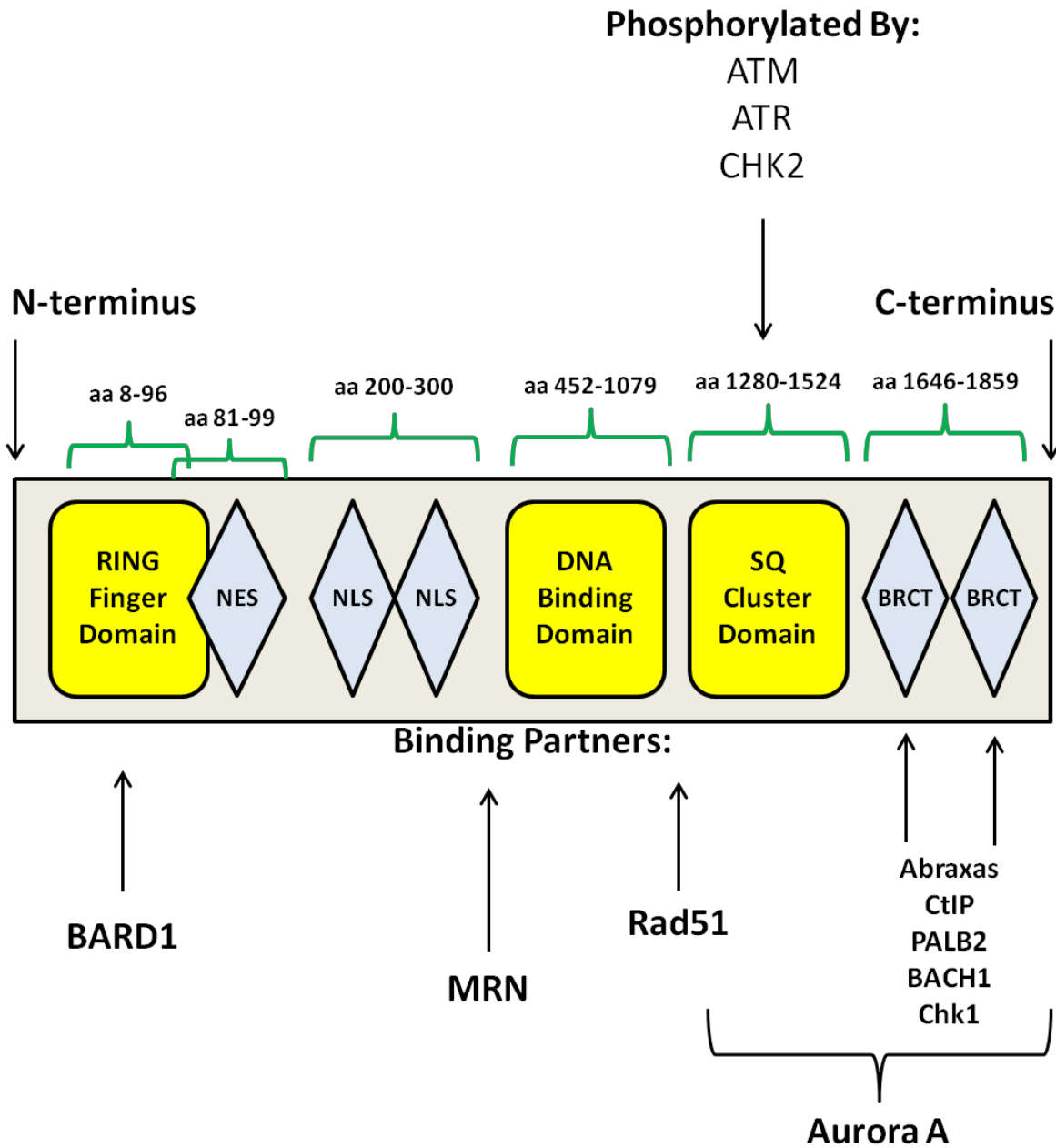

Figure 2.3 – BRCA1 functional domains and select binding partners.

Adapted from Narod and Foulkes, 2004, and Caestecker and Van de Walle, 2013.

aa: Amino acids, NES: nuclear export signal, NLS: nuclear localization signal, SQ: serine/glutamine, BRCT: BRCA1 C-terminal domains

ubiquitin ligase activity is important for normal cellular function, including the G2/M checkpoint and mitosis.

The SQ cluster domain is a region of serine and threonine residues ranging from amino acids 1241-1530. These residues are phosphorylated by ATM and ATR in response to DNA damage (among other stimuli). ATM is the main kinase that phosphorylates BRCA1 in response to ionizing radiation (Cortez et al., 1999; Gatei et al., 2000). ATR has redundant/backup phosphorylation duties to/for ATM, and, as previously mentioned, is activated by stimuli such as ultraviolet radiation and stalled replication forks (Tibbetts et al., 2000). The redundant serine residues that are phosphorylated by ATM and/or ATR are S1387, S1423, S1457, and S1524. Serine 1387 is phosphorylated only by ATM (in response to irradiation), while serine 1457 is uniquely phosphorylated by ATR in response to ultraviolet radiation (Gatei et al., 2001).

Many of these phosphorylations seem to have direct consequences for cell cycle control. Serine 1387 phosphorylation is involved in the intra-S checkpoint, whereas the phosphorylation of serines 1423 and 1524 is important for G2/M checkpoint activation (Xu et al., 2001, 2002). Additional phosphorylations outside of the serine cluster domain are also important for

checkpoint control. For example, Chk2 phosphorylates BRCA1 on serine 988 in response to microtubule damage, inhibiting the microtubule nucleation activity of BRCA1 and preventing the proper transition to, and through, mitosis (Chabalier-Taste et al., 2008). Additionally, Ouchi et al found that phosphorylation of serine 308 by the Aurora-A kinase is necessary to successfully traverse the G2/M checkpoint (Ouchi et al., 2004)(discussed further in this chapter, as well as Chapter 5).

The BRCA1 BRCT domains bind phospho-proteins containing the phospho-serine-X-X-phenylalanine (pSer-X-X-Phe) motif, where "X" represents any amino acid (Manke et al., 2003; Yu et al., 2003). The four most heavily studied BRCT binding partners of BRCA1 are Abraxas, BACH1, CtIP, and PALB2 (Caestecker and Van de Walle, 2013; Wang et al., 2007; Yu and Chen, 2004). Abraxas bridges another protein, RAP80, to BRCA1. This complex, along with the BRCA1-BACH1 and BRCA1-CtIP complexes, have all been shown to be involved in the homologous repair of DSBs (Litman et al., 2005; Sartori et al., 2007; Yan et al., 2007). The BRCA1-Abraxas-RAP80 complex is important because RAP80 localizes BRCA1 to sites of DSBs through its dual ubiquitin-interacting motifs, which are attracted to polyubiquitinated H2AX (a post-translation modification of H2AX mediated by MDC1 which occurs at sites of DSBs) (Caestecker and Van de Walle, 2013; Sobhian et al., 2007).

Additional work has demonstrated that BACH1, a helicase, is involved in S-phase progression, and it has been shown that mutations in BACH1 interferes with normal DSB repair, suggesting that the BRCA1-BACH1 interaction is essential to BRCA1's DNA repair function (Cantor et al., 2001; Kumaraswamy and Shiekhattar, 2007).

The final major BRCA1-BRCT interacting protein, CtIP, has been shown to be important for BRCA1's function in the G2/M checkpoint. In 2004, it was found that the BRCA1-CtIP complex only existed in the G2 phase of the cell cycle, and that this interaction is necessary for the DNA damage-induced phosphorylation of Chk1 and activation of the G2/M checkpoint (Yu and Chen, 2004). Later, the same group demonstrated that CtIP was ubiquitinated by BRCA1. This ubiquitination does not signal CtIP for destruction, rather, it promotes CtIP's association with chromatin following DNA damage, and was also found to be necessary for G2/M checkpoint activation (Yu et al., 2006).

BRCA1's role in cell cycle control goes far beyond its interaction with CtIP. The BRCT domain has also been found to function in transcription of the p21 promoter through its

association with p53 (Chai et al., 1999; Li et al., 1999; Ouchi et al., 1998; Zhang et al., 1998). After DNA damage, CtIP can dissociate from BRCA1, allowing p53 to bind which leads to the transcriptionally-mediated aspect of cell cycle control (as well as DNA repair). Along these same lines, BRCA1 can also associate with the acetyltransferase complex CBP/p300, which further increases the BRCA1-p53 dependent transcriptional activity (Pao et al., 2000). As p53 has been shown to be active in both the G1/S and G2/M checkpoints (Agarwal et al., 1995), it is probable that BRCA1 is also involved in both of these major checkpoints.

Another experimentally validated model for BRCA1's function in the cell cycle revolves around its regulation of centrosomes. Centrosomes are cellular organelles that nucleate microtubules throughout interphase and mitosis (Moritz et al., 1995). Centrosomes duplicate once per cell cycle and, during mitosis, move to opposite ends of the cell forming the bipolar mitotic spindle (see (Morgan, 2007) for review). BRCA1, along with BARD1, have been found to localize to the centrosome and ensure that centrosomal duplication occurs only once per cell cycle, a process which is important in preventing the formation of multipolar mitotic spindles, unequal chromosome segregation, and aneuploidy (Sankaran et al., 2005, 2006; Starita et al., 2004).

In cells containing BRCA1 mutations, centrosomal amplification and aneuploidy are commonly recorded events, leading to and enhancing the neoplastic transformation of these cells (Deng, 2001; Schlegel et al., 2003; Starita et al., 2004; Xu et al., 1999). The BRCA1-BARD1 complex ubiquitinates γ -tubulin, a modification that regulates the initial nucleation of microtubules at centrosomes (Sankaran et al., 2005). Microtubule nucleation involves taking free tubulin dimers and assembling them into a stable aggregate known as "nucleation centers". The most important nucleation center is known as the γ -tubulin ring complex, or γ -TuRC. It is here where the BRCA1-BARD1 heterodimer exerts its regulation, by ubiquitinating and preventing excessive nucleation and spindle formation (Sankaran et al., 2007; Starita et al., 2004). Recent work has demonstrated that the protein CRM1 (chromosome region maintenance 1) mediates the nuclear export of BRCA1, as well as its localization to centrosomes (Brodie and Henderson, 2012). This same report showed that Aurora A's binding and phosphorylation of BRCA1 was important for its centrosomal retention (discussed further in Chapter 4).

BRCA1's ubiquitin-mediated cell cycle control is not limited to centrosomes. It was previously shown that in response to DNA damage, BRCA1 was crucial to G2/M arrest by its downregulation of Cyclin B/CDK1 and Cdc25C (Yarden et al., 2002, 2012).

However, the mechanism by which this occurred was unknown. In late 2012, the Yarden lab demonstrated that this downregulation was due to BRCA1's E3 ubiquitin ligase activity. After DNA damage (induced by either γ -irradiation or Neocarzinostatin), the BRCA1-BARD1 complex polyubiquitinates both Cyclin B and Cdc25C, which leads to their proteasomal degradation (Shabbeer et al., 2012). Without these crucial proteins, the transition to mitosis cannot occur.

BRCA1, much like ATM, clearly plays diverse and important roles in the protection of cellular structure and function. While a number of stimuli have been shown to cause distinct post-translation modifications of BRCA1 (leading to downstream effects), much investigation remains to be done to fully elucidate all the mechanisms by which BRCA1 exerts its caretaker functions. As it stands, BRCA1 appears to have widespread influence over the life cycle of the cell.

Aurora A kinase

Aurora A is a 48 kDa protein comprised of 403 amino acids, with its important kinase domain spanning from amino acids 133-383. It was first crystallized in 2002, and there are now at least 57 crystal structures of Aurora A in complexes with other proteins or pharmacologic inhibitors (Nikonova et al., 2013).

In regards to the cellular life cycle, it has been well documented that Aurora A functions in both centrosomal regulation and the progression through mitosis. In S phase (after centrosomal replication), Aurora A begins to accumulate at the centrosomes, where it is responsible for recruiting a number of proteins to the pericentrosomal material, such as γ -tubulin, centrosomin, LATS2, TACC, and NDEL1 (Abe et al., 2006; Conte et al., 2003; Hannak et al., 2001; Mori et al., 2007; Toji et al., 2004). These proteins, along with Aurora A, increase the microtubule nucleation activity of the centrosomes.

The events responsible for Aurora A activation are not clear-cut. Indeed, there are a multitude of different interactions and phosphorylations which can influence Aurora A's activity. The earliest described (and most thoroughly studied) cofactor of Aurora A activation is TPX2. TPX2 binds to Aurora A and helps

target it to the mitotic spindles (Kufer et al., 2002). Once TPX2 binds, the activation segment of Aurora A moves inside the kinase's catalytic pocket, inducing the autophosphorylation of threonine 288 (Bayliss et al., 2003; Evers et al., 2003). The binding of TPX2 also protects Aurora A from the deactivating functions of protein phosphatase 1 (PP1) by "hiding" the threonine 288 residue from the enzymatic activity of PP1 (Bayliss et al., 2003; Evers et al., 2003).

Two other important cofactors are Ajuba and Bora, to which Aurora A binds and phosphorylates. Circuitously, Ajuba binding is necessary for Aurora A autophosphorylation (which, in turn, phosphorylates Ajuba) (Hirota et al., 2003). This activation takes place at the centrosomes, and is crucial for the activation of the Cyclin B/CDK1 complex. Similarly to Ajuba, Bora binding and phosphorylation enhances Aurora A's kinase activity (Hutterer et al., 2006), though the exact function of this interaction remains unclear. Studies in *Drosophila* identified Bora as important for asymmetric cell division, which would play into Aurora A's role in regulating mitosis (Berdnik and Knoblich, 2002).

There are several additional proteins which experimental data

has demonstrated to be involved in Aurora A's activation (see (Nikonova et al., 2013) for a helpful summary). At present, however, the literature is murky in regards to what exactly these proteins are doing, and why. This likely stems from the fact that several different model systems have been used to study Aurora A (*Xenopus*, *Drosophila*, etc.) and not all functions/interactions are conserved across species. The big picture question involves solving how all these cofactors work together to regulate Aurora A's function.

Once activated, Aurora A is involved in several downstream pathways (see **Figure 2.4** for an overview of key Aurora A functions). As previously stated, Aurora A (coupled with Bora) is key in activating the Cyclin B/CDK1 complex. This complex is initially gathered and activated at centrosomes, and Aurora A positively reinforces this activation (Jackman et al., 2003; De Souza et al., 2000). The hypothesized signaling pathway has an activated Aurora A/Bora complex phosphorylating and activating Plk1. Plk1, once activated, feeds into the loop of recruiting more Aurora A to the centrosomes, where Aurora A can then phosphorylate Cdc25B (Dutertre et al., 2004). Cdc25B is required for the initial centrosomal activation of the Cyclin B/CDK1 complex (Lindqvist et al., 2005), providing a mechanism by which Aurora A can directly push cells through the G2/M transition.

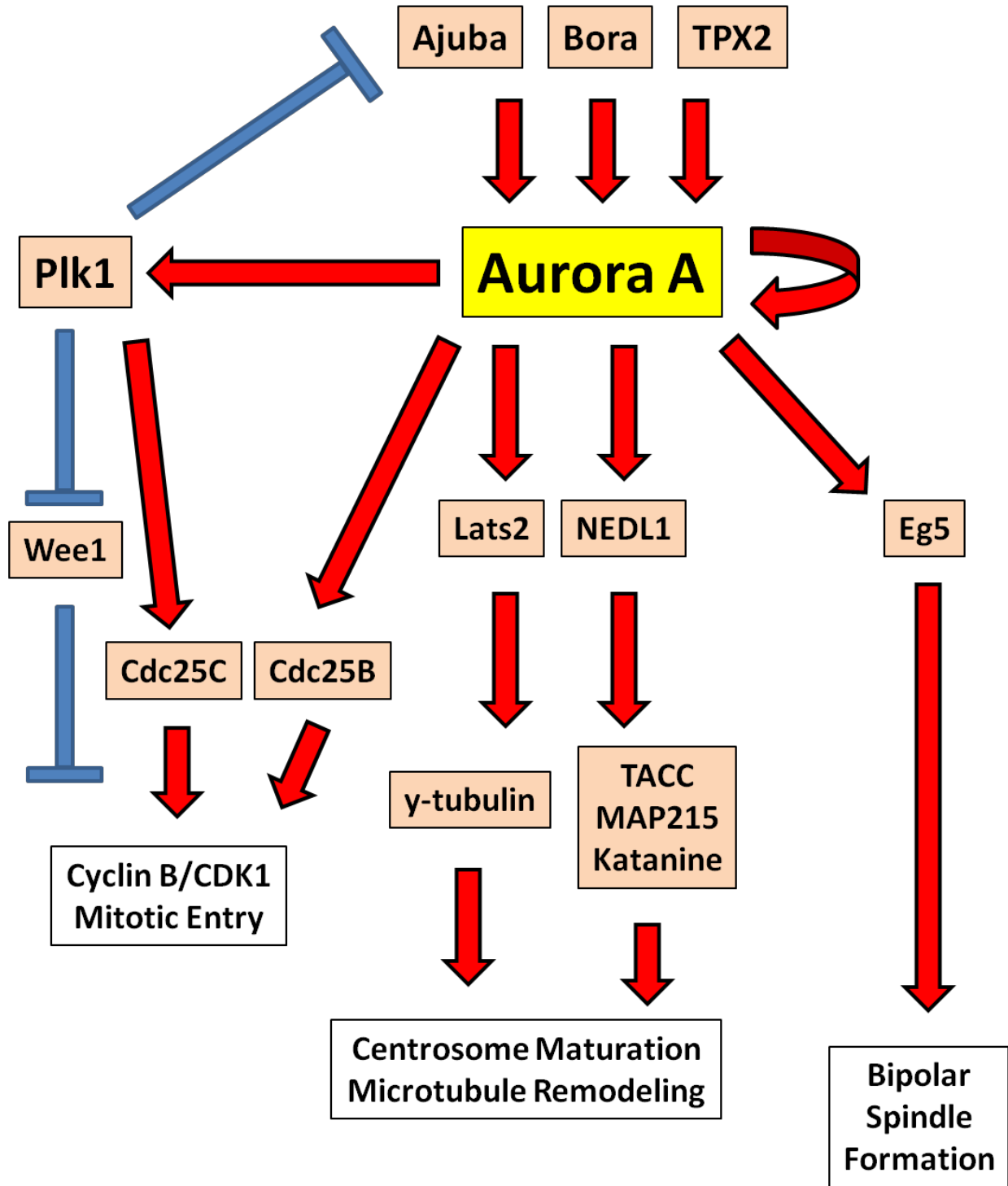

Figure 2.4 – Overview of select Aurora A kinase functions.

Adapted from Katayama and Sen, 2010.

Several studies have investigated the consequences of Aurora A mutation/inhibition on centrosomal maturation and bipolar spindle formation. Often, depletion of Aurora A leads to monopolar spindle formation, preventing the accurate progression through mitosis (Glover et al., 1995; Hannak et al., 2001; Liu and Ruderman, 2006; Roghi et al., 1998). There are several possible mechanisms by which this takes place. Aurora A has been shown to phosphorylate Eg5, a kinesin which is involved in centrosome separation (Giet et al., 1999). However, it is not known if this phosphorylation is essential for Eg5's activity.

Aurora A also targets and phosphorylates a protein called LIMK1. As is the case with Eg5, LIMK1 is a proposed regulator of bipolar spindle formation, but it is not known if Aurora A's phosphorylation is important for this function (Chakrabarti et al., 2007; Ritchey et al., 2012). This phosphorylation is important, however, for the mitotic co-localization of Aurora A and LIMK1. Additionally, Aurora A is known to affect astral microtubules, which connect centrosomes to the cell cortex and can influence bipolar mitotic spindle formation (Giet et al., 1999). Further work needs to be done in this area in order to fully elucidate how Aurora A contributes to spindle formation, and, in return, function (see (Nikonova et al., 2013) for discussion).

Finally, once Aurora A has completed its duties in shepherding cells through mitosis, it needs to be degraded (unlike ATM and BRCA1, which function throughout the cell cycle). This is done through an E3 ubiquitin ligase named the Anaphase Promoting Complex/Cyclosome (APC/C) (Vader and Lens, 2008). At the end of mitosis, Aurora A is targeted for destruction, a mechanism by which it is ensured that low levels of mitosis-promoting proteins exist in G1. However, mutations in Aurora A (or other proteins) can arise which prevent its destruction, enhance its function, or alter key activities. When this occurs, malignancy can result.

Aurora A has been shown to be mutated in a number of cancers (see (Katayama et al., 2003), for example). However, isolated mutations in Aurora A are not enough to induce malignancy (Zhou et al., 1998), indicating that other oncogenic events must take place before a cancerous Aurora A phenotype can arise (Tatsuka et al., 2005). Aurora A is located on chromosome 20q13.2, a region which is frequently amplified in solid tumors (Nikonova et al., 2013). Typical features of pathologic Aurora A function include amplified centrosomes, multipolar spindles, aneuploidy, and deficient cell cycle checkpoints (Meraldi et al., 2002; Nikonova et al., 2013).

Aurora A's neoplastic potential has been shown to depend on p53 status. Aurora A directly phosphorylates p53, and, like ATM and BRCA1, stabilizes it, leading to downstream transcriptional events (Katayama et al., 2004; Liu et al., 2004). In mouse models, Aurora A was unable to produce tumors except in a p53-knockout background (Fukasawa et al., 1996). This is presumed to be caused by the aneuploid cells coming up against the p53-mediated G1/S checkpoint which, when intact, activates and sends cells into senescence/death (Fukasawa et al., 1996). While Aurora A can activate p53 through phosphorylation, it can also inhibit it. By phosphorylating Serine 315 of p53, Aurora A increases the MDM2-dependent degradation of the protein (Katayama et al., 2004). Conversely, p53 can bind to the catalytic domain of Aurora A, inhibiting it (Chen et al., 2002; Evers et al., 2003).

Recently, this relationship was highlighted as a key factor in maintaining stem cell pluripotency. Using a short hairpin (sh) RNA screen, Lee et al found that depleting Aurora A resulted in compromised self-renewal, leading to differentiation. They discovered that loss of Aurora A leads to upregulated p53, a finding which supports previous studies (i.e. (Katayama et al., 2004). Phosphorylation of p53 by Aurora A also downregulated the

p53-mediated suppression of iPS cell reprogramming (Lee et al., 2012). Few other studies have been conducted on Aurora A and ES cells. In conditional knockout mice, it was shown that differential Aurora A expression can influence early mouse embryo patterning (while complete knockout was found to be embryonically lethal) (Yoon et al., 2012). Additionally, it was also shown (again in mice) that Aurora A is crucial for epidermal differentiation and development. Epidermal deficiency of Aurora A was shown to promote aberrant mitosis, mitotic slippage, and cell death (Torchia et al., 2013). Clearly, more research is needed in this area to clarify what role Aurora A plays in both pluripotent and somatic cells.

Chapter 3:

Modulation of ATM function: effects on the cell cycle

Over the past fifteen years, the successful culture and propagation of human embryonic stem cells has generated new hope for the development of novel therapies based in regenerative medicine. Unlike somatic cells, hESCs can be cultured in an undifferentiated state for long periods, while retaining the ability to form cells of all three embryonic germ layers (Thomson et al., 1998). Unfortunately, therapies have been slow to develop, as obstacles to expanding these cells *ex vivo* have arisen.

One such obstacle is aneuploidy. Mouse, human, and induced pluripotent stem cells fail to remain euploid after prolonged culturing (Draper et al., 2004; Longo et al., 1997; Mayshar et al., 2010). If aneuploid/genetically unstable hESCs are transplanted, cancer can result (Amariglio et al., 2009). Malignant transformation arises from cells acquiring errors in their genome, resulting in a gain of function or loss of regulation. To prevent these genomic flaws from inciting unwarranted growth, cells have evolved methods to arrest the cell cycle and repair the detected mistakes. If the DNA cannot be repaired, cells undergo apoptosis, a small sacrifice to preserve the larger organism. If cells fail to arrest and apoptosis does not occur, cancer can develop, leading to loss of function and, if left untreated, death.

As hESCs display a shortened G1 phase (2.5 – 3 hours) and a “leaky” G1/S checkpoint (Boheler, 2009; Nospikel, 2013), there is increased pressure on the G2/M checkpoint to detect any genetic abnormalities and arrest the cell appropriately. Two significant events will trigger a checkpoint at the mitotic boundary: DNA damage and/or catenated chromatin (Downes et al., 1994). The fact that DNA damage can produce genomic instability is a well-known and well-studied process (see (Abbas et al., 2013), for example. However, what role decatenation and the decatenation checkpoint plays in retaining genetic fidelity is much more poorly understood. If a cell fails to properly decatenate its chromosomes, a cell cycle checkpoint (distinct from the DNA damage checkpoint) activates, arresting cells at the G2/M phase (Downes et al., 1994). If the checkpoint does not activate, and cells complete division with catenated chromosomes, nondisjunction and breakage can occur. This can lead to translocations and other abnormalities in daughter cells.

Previous work has described a deficient decatenation checkpoint in mouse embryonic stem cells (Damelin et al., 2005), and progress has been made towards characterizing the checkpoint’s pathway. Recently, it has been posited that the DNA damage

signaling protein ATM mediates the decatenation checkpoint (Bower et al., 2010b), though the exact cascade remains unknown. ATM's potential involvement is significant because previous work from our lab has demonstrated that ATM, while present in hESCs, does not play its canonical role in double strand break repair in pluripotent cells (Adams et al., 2010a). This finding has been supported by other labs (see (Nagarria et al., 2013) for review).

The purpose of this study is to clarify what role ATM plays in hESCs. A previous report demonstrated that ATM is activated in response to DNA damage in hESCs, and that cells arrest in G2 (Momcilović et al., 2009). These researchers then went on to show, using the ATM specific inhibitor KU-55933, that this arrest could be abrogated. However, Momcilovic et al drew these conclusions using an immense dose of KU-55933 (100 μ M, 10x the concentration normally used), a dose that could conceivably affect several other proteins involved in the DNA damage response.

Herein, we will investigate the role of ATM in cell cycle control using the next-generation ATM inhibitor, KU-60019. We have demonstrated KU-60019 to be a highly potent, highly specific inhibitor of ATM (Golding et al., 2009). We

successfully demonstrate that, in hESCs, ATM is activated in response to DNA damage as well as the inhibition of decatenation. Both of these insults cause a G2/M arrest, and this arrest is abrogated by the inhibition of ATM, supporting the hypothesis that ATM mediates the G2/M checkpoint. Additionally, we show, using live cell imaging, that inhibiting ATM significantly increases the time it takes for cells to complete mitosis. When decatenation is inhibited concurrently with ATM, cells will enter mitosis and fail to separate, essentially "giving up" and re-entering the cell cycle with double the normal amount of DNA. Following up on this finding, we show that prolonged culture under ATM inhibition causes an increase in DNA content, and that wash out and culture of cells in normal media begins to reverse this effect.

Materials and Methods

Antibodies, reagents, and irradiation:

Antibodies used were anti-p-ATM (1:1000) (Cell Signaling), -ATM (1:1000) (GeneTex, Inc.), -DNA-PK (1:1000) (BD Pharmingen), -p-Histone H3 (1:500) (Cell Signaling Technologies), -CREST (1:75) (Fitzgerald Industries), and -Cyclin A (1:50) (Santa Cruz Biotechnologies). KU-60019 (provided by KuDOS Pharmaceuticals, Inc.) was dissolved in DMSO and used at a concentration of 3 μ M. ICRF-193 (Enzo Life Sciences) was dissolved in DMSO and used at a concentration of 10 μ M. Colcemid (Sigma-Aldrich) and nocodazole (Sigma-Aldrich) were dissolved in DMSO and used at concentrations of 100 ng and 100 nM, respectively. Irradiations were performed using a MDS Nordion Gammacell 40 research irradiator with a Cs-137 source delivering an approximate dose of 1.05 Gy/min.

Cell culture:

The human ESCs BG01V (ATCC, Rockville, MD), H9 (Thomson et al., 1998), and H9-(v)1 (Werbowetski-Ogilvie et al., 2009) were cultured on a feeder-free system using a Matrigel™ (BD Biosciences) basement membrane substrate and mTeSR™ (STEMCELL Technologies) or Stemline™ (Sigma-Aldrich) media. Matrigel™ coated dishes were created using WiCell™ protocols. The media

was changed daily and cells were passaged with Dispase™ (STEMCELL Technologies) at least once every five days. Experiments were performed 24-48 hours after passaging.

Western blotting:

Western blotting was performed as previously described (Adams et al., 2010a) with additional modifications. Cells were lysed in RIPA buffer supplemented with HALT™ protease and phosphatase inhibitors (Sigma-Aldrich). Proteins were separated on Criterion™ TGX gels (Bio-Rad Laboratories) and transferred to PVDF membranes, which were exposed to primary antibodies at a 1:1000 dilution. Protein bands were detected and quantified using infrared-emitting conjugated secondary antibodies, either anti-rabbit DyeLight 800 (Rockland Immunochemicals, Gilbertsville PA) or anti-mouse Alexa 680 (Invitrogen) using the Odyssey infrared imaging system from Li-Cor Biosciences (Lincoln, NE). Densitometry was performed using ImageJ or Image Studio v2.0.

Metaphase spreads and pseudomitotic index:

Acquisition of metaphase spreads was accomplished as previously described (Campos et al., 2009). Cells and culture media were collected and centrifuged. The resulting pellet was resuspended in a hypotonic potassium chloride solution. The preparation was

fixed in a freshly made 3:1 methanol:acetic acid solution and dropped onto glass slides. The slides were dried over a steam bath and stained with Giemsa (Sigma-Aldrich). They were then imaged using the Ariol automated image analysis system (Molecular Devices LTD). Nuclei and metaphase spreads were counted using ImageJ. The percentage of entangled chromosomes ("pseudomitoses") in ICRF-193 cells were divided by the percentage of metaphase spreads in cells treated with colcemid alone, giving the pseudomitotic index (Damelin et al., 2005).

Flow cytometry:

Cells were fixed in 100% methanol, permeabilized in 1% Triton X-100/casein, and incubated with anti-phospho-Histone H3 antibody at 1:500 dilution for 1 h 30 min at room temperature. Cells were washed in PBS and incubated with goat anti-rabbit Alexa Fluor 488 at 1:500 dilution for 45 min at room temperature. Cell cycle distribution was analyzed by propidium iodide staining (5 Ag/mL, 0.1% Triton X-100/PBS). Flow cytometry was done on a BD Biosciences FACS Canto flow cytometer at the VCU Flow Cytometry Core Facility. Data was analyzed using the FACSDiva software.

Confocal imaging:

Confocal imaging was performed as described previously (Adams et al., 2010a) with additional modifications. Cells were grown on Lab-Tek (Naperville, IL) glass slides coated with Matrigel. After treatment, cells were fixed with 3% paraformaldehyde, permeabilized with 0.5% Triton-X 100 in phosphate-buffered saline (PBS) and blocked with casein/3% goat serum. Primary antibodies were incubated overnight at 4 degrees, with rotation (using the concentrations listed previously). The next day, samples were incubated for 2.5 hours at room temperature with a secondary antibodies solution (Alexa 488 goat anti-rabbit or goat anti-mouse 546 Fab fragment (Invitrogen)) at a 1:400 dilution. The nuclei were counterstained with DAPI (1 mg/ml). Cells were imaged using a Zeiss LSM 710 Meta imaging system in the VCU Microscopy Facility and analyzed using the Volocity software from PerkinElmer.

Live-cell imaging:

Live-cell imaging was performed as described in (Beckta et al., 2012), using a Zeiss Cell Observer SD spinning disk confocal microscope. BG01V hESCs were transduced with a Histone H2B-mCherry construct to visualize chromatin. Glass-bottom dishes were coated with Matrigel and cells were passaged onto these dishes 24-48 hours prior to recording. Cells were kept on an

incubated stage at 37°C and 5% CO₂. Videos were analyzed using PerkinElmer's Volocity software.

Statistics:

ANOVA, t-tests, and linear regression were performed using GraphPad Prism 3.0 (GraphPad Software, Inc). P values are indicated as *, 0.05, **, 0.01, and ***, 0.001.

Results

ATM is present and active in hESCs. KU-60019 inhibits ATM activation in response to irradiation.

Studies were conducted using the BG01V, H9, and H9 variant H9-(v)1 hESC lines. Our lab has previously developed optimal conditions for the growth and propagation of hESCs (Adams et al., 2010a). Notably, we employ a basement membrane substrate to grow the hESCs, thus avoiding the use of MEF feeder layers and ensuring our cultures are free of xenobiotic contamination. Successful maintenance of the pluripotent state was verified by immunocytochemistry (ICC) for SSEA-4 (**Figure 3.1**). Western blotting was used to confirm that ATM was present and active in the hESCs, and that KU-60019, a drug which we have shown to be a highly effective inhibitor of ATM (Golding et al., 2009), functioned as expected at a concentration which we have determined only inhibits ATM. hESCs were exposed to 3 μ M of KU-60019, 2 Gy of radiation, or both KU-60019 and radiation. KU-60019 was added 30 minutes before irradiation; cells were harvested 30 minutes after irradiation. Predictably, irradiation catalyzed the activation of ATM, and KU-60019 abrogated this effect (**Figure 3.2**).

hESCs

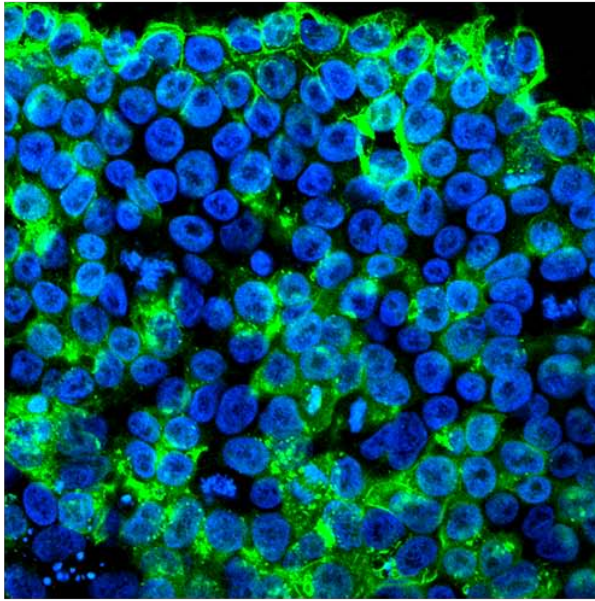

hESC-derived astrocytes

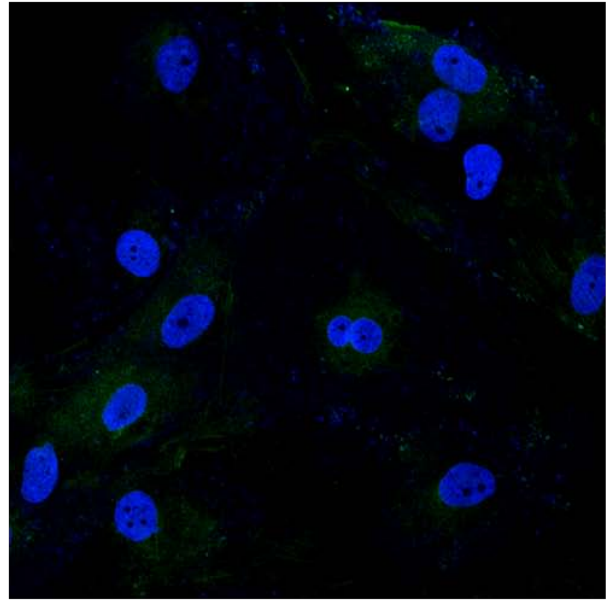

Figure 3.1 – Verification of pluripotency through SSEA-4 immunocytochemistry.

hESCs and hESC-derived astrocytes were stained with SSEA-4 and compared. Pluripotent hESCs stained positive for SSEA-4, while terminally differentiated astrocytes did not.

Green = SSEA-4, Blue = DAPI

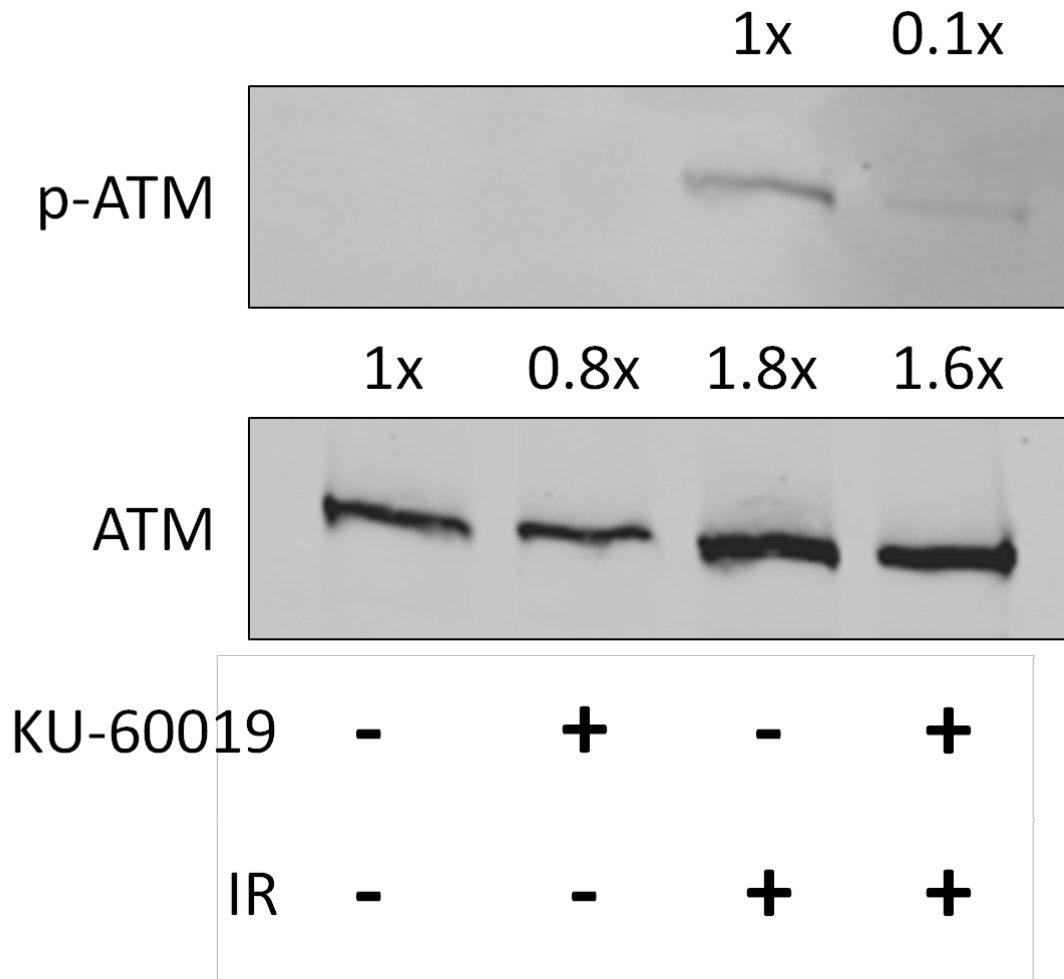

Figure 3.2 – ATM is present and active in hESCs.
KU-60019 inhibits ATM activation in response to irradiation.
 Cells were treated with KU-60019 30 minutes prior to irradiation and harvested 30 minutes after irradiation.

Catalytic inhibition of Topoisomerase II activates ATM and accumulates cells in G2. KU-60019 inhibits ATM activation.

During and after DNA replication, daughter chromatids contain areas of entanglement, or catenations. The ability of cells to resolve these entanglements is dependent upon topoisomerase II (topoII), which unravels the chromosomes via the same method it uses to relieve helical stress. In order to inhibit decatenation, we used the bisdioxopiperazine ICRF-193, a topoII catalytic inhibitor that does not cause DNA double strand breaks (Roca et al., 1994). Treatment with 10 μ M of ICRF-193 for four hours caused significant ATM activation in S and G2 phase, though this activation occurred most significantly in G2 (**Figure 3**). Exposure to KU-60019 in addition to ICRF-193 inhibited ATM activation (**Figure 3.3**). Cell cycle analysis revealed that in contrast to control or KU-treated cells, exposure to ICRF-193 accumulated cells in G2 (**Figure 3.4**). These data indicate that after catalytic inhibition of topoisomerase II, hESCs activate ATM and enact the decatenation checkpoint.

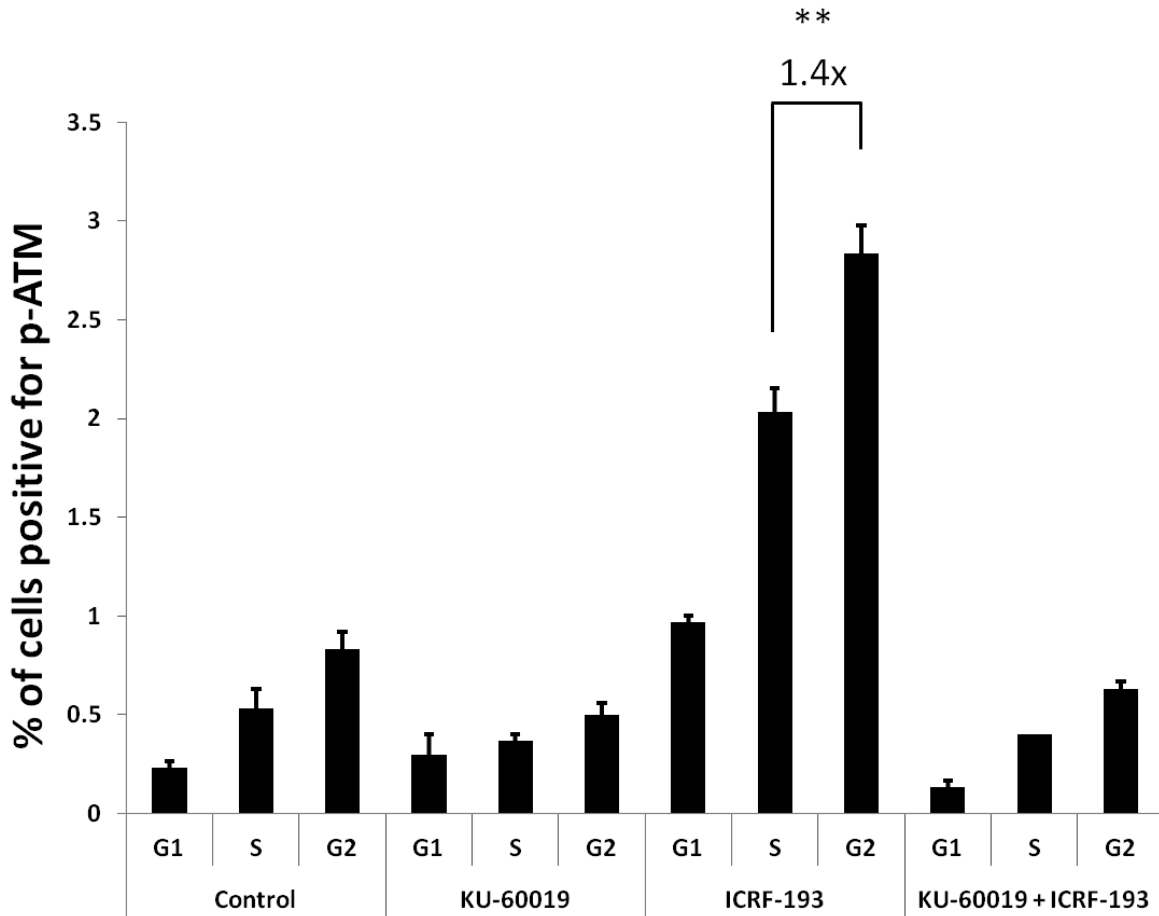
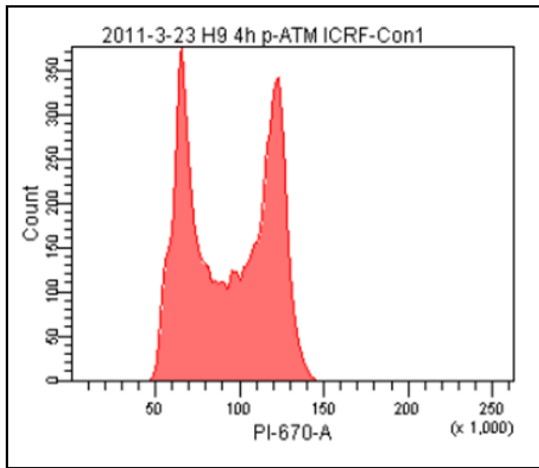

Figure 3.3 – Catalytic inhibition of topoisomerase II activates ATM, most significantly in S and G2. KU-60019 inhibits ATM activation.

hESCs were treated with KU-60019 for 30 minutes before addition of ICRF-193. Cells were harvested after 4 hours of continual drug exposure, immuno-labeled with a phospho-ATM antibody, and assayed by flow cytometry.

** = $p < 0.01$



Control

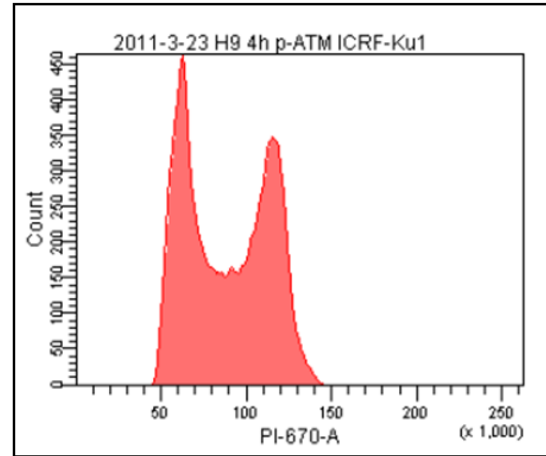

KU-60019 Treated

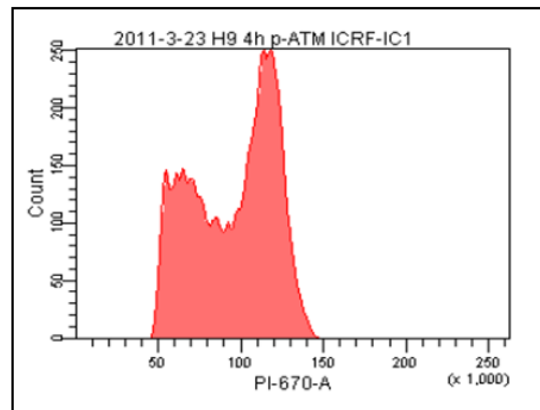

**ICRF-193 Treated
Cells Accumulate in G2**

**Figure 3.4 – Catalytic inhibition of topoisomerase II arrests hESCs
In G2.**

hESCs were exposed to drugs for 4 hours, stained with propidium iodide and assayed by flow cytometry.

Inhibition of ATM abrogates both the DNA damage and the decatenation checkpoints.

The purpose of a G2 arrest is to prevent damaged cells from entering mitosis and passing on any deleterious genetic lesions to daughter cells. Thus, we determined the mitotic accumulation of hESCs after inhibition of decatenation to assess the effectiveness of the G2/M checkpoint. To ensure that we are looking exclusively at G2/M entry (and prevent any confounding results from differences in mitotic exit) we used colcemid, a microtubule poison that prevents mitotic exit (Bower et al., 2010b). H9, H9-v1, and BG01V cells were treated for four hours with KU-60019, ICRF-193, or both KU-60019 and ICRF-193, and analyzed for positive staining of phospho-Histone H3 (an established marker of mitosis). Catalytic inhibition of TopoII significantly reduced mitotic accumulation; inhibition of ATM abolished this effect (**Figures 3.5A, 3.5B, 3.5C**). This result was also observed in hESCs treated with irradiation (**Figure 3.6A**).

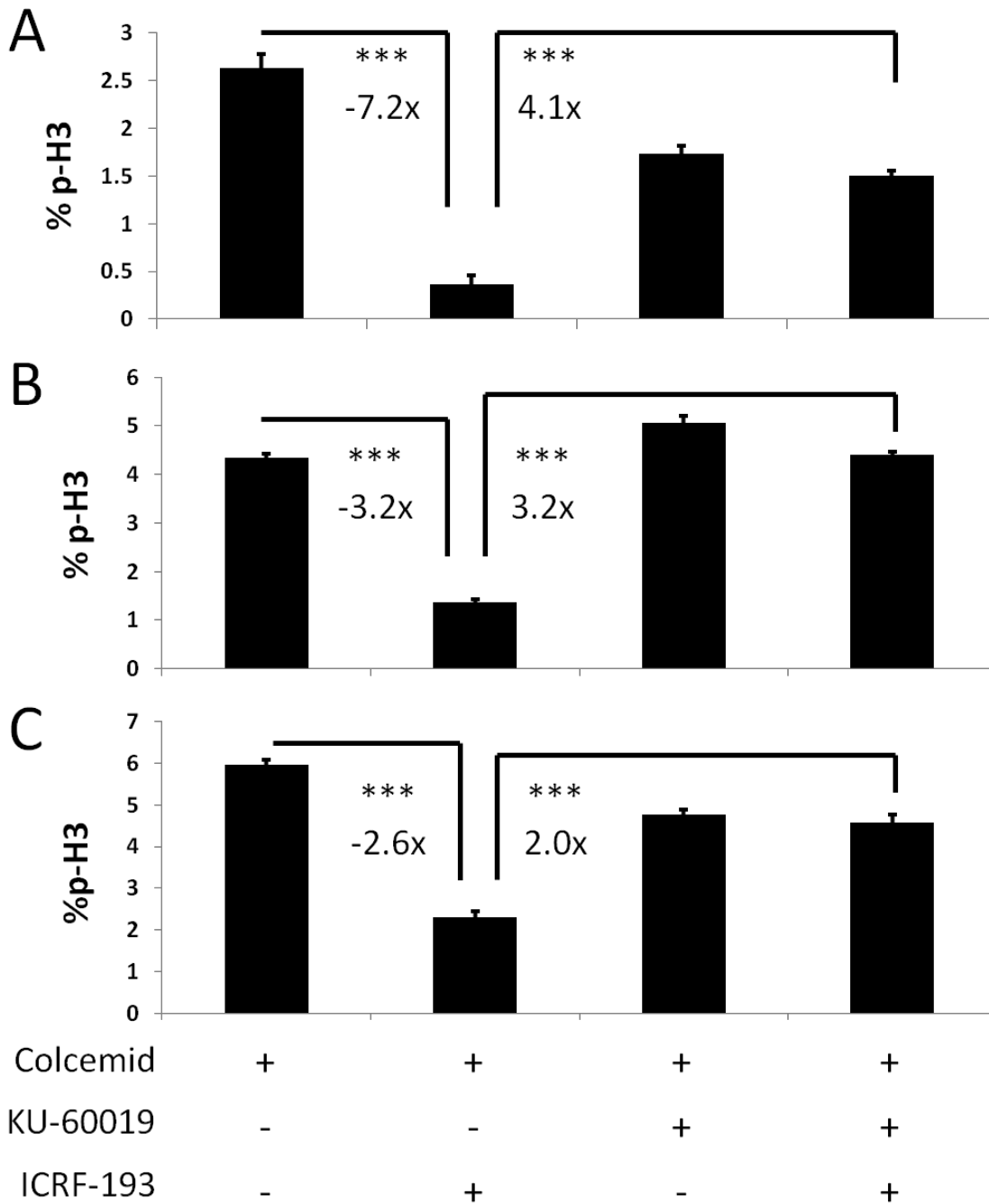

Figure 3.5 – Inhibition of ATM abrogates the decatenation checkpoint.

A) H9, B) H9-v1, and C) BG01V hESCs were treated with or without KU-60019 and/or ICRF-193 and the mitotic index was measured after 4 hours using immuno-labeling for phospho-Histone H3 and flow cytometry.

*** = $p < 0.001$

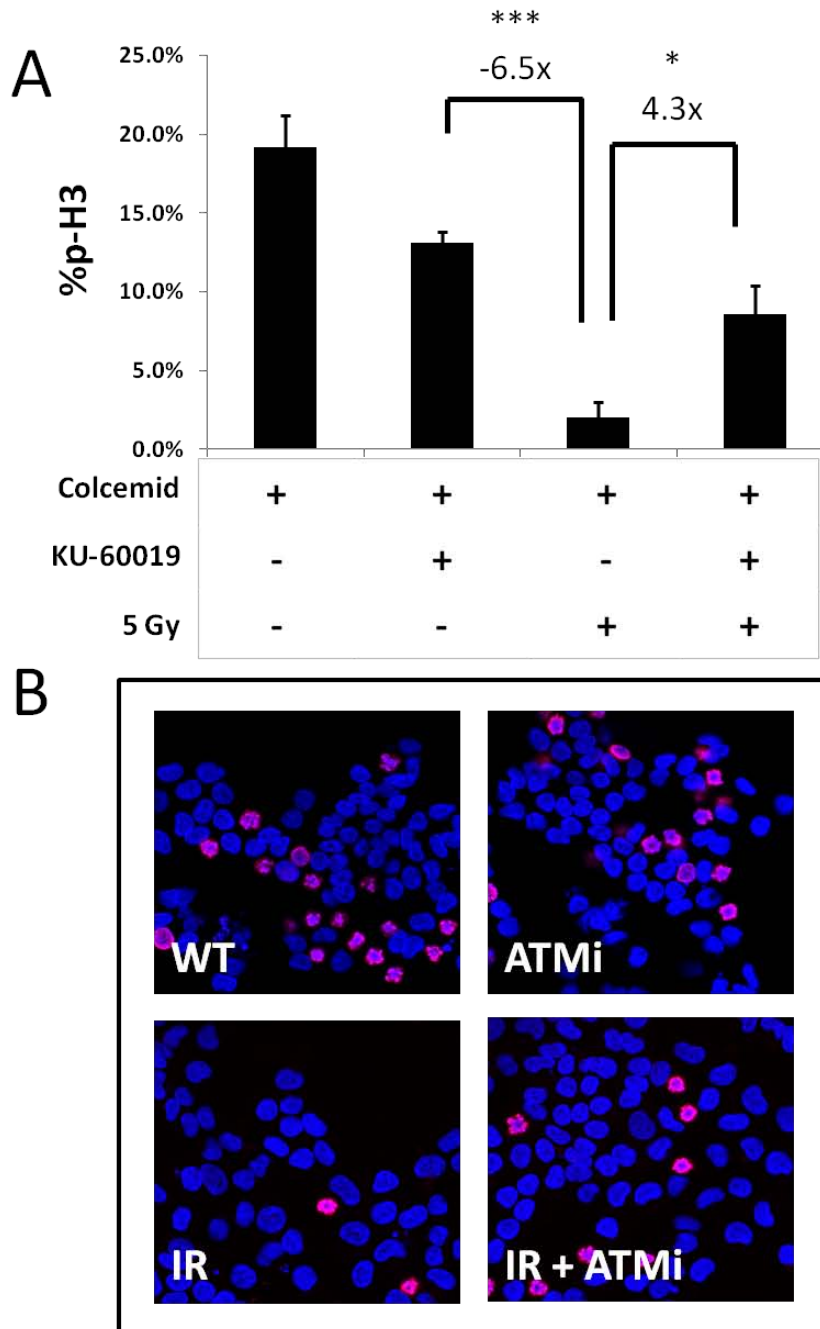

Figure 3.6 – Inhibition of ATM abrogates the G2/M DNA Damage Checkpoint. hESCs were treated with KU-60019 and Colcemid 30 minutes prior to irradiation and were then exposed to 5 Gy. Cells were fixed 4 hours after IR and assayed by confocal microscopy. **A)** Mitotic Index, **B)** Representative images from the quantitative data in **A**. Blue = DAPI, Red = p-Histone H3

* = $p < 0.05$, *** = $p < 0.001$

Inhibition of ATM abrogates the decatenation checkpoint and increases the mitotic entry rate.

In order to calculate the mitotic entry rate of hESCs, H9 cells were exposed to ICRF-193 and/or KU-60019 for 2, 4, and 6 hours. ICRF-193 reduced the mitotic accumulation and rate of accumulation, decreasing the slope (from colcemid-only control) by 2.7 fold. When KU-60019 was added simultaneously with ICRF-193, mitotic accumulation recovered, and the mitotic entry rate rose dramatically, increasing the slope nearly 2 fold (**Figure 3.7A**). BG01V hESCs were exposed to the same treatments. Similar to the H9 cells, ICRF-193 reduced the mitotic accumulation and rate of accumulation (decreasing the slope 1.5 fold). When KU-60019 was added simultaneously with ICRF-193, mitotic accumulation recovered, and the mitotic entry rate increased (increasing the slope 1.3 fold) (**Figure 3.7B**).

Inhibition of ATM significantly decreases the efficiency of the decatenation checkpoint.

To determine the efficiency of the checkpoint, we used metaphase spreads and calculated the pseudomitotic index, which is defined as "the frequency of pseudomitosis in ICRF-193-treated cells divided by the frequency of mitosis in mock-treated cells"

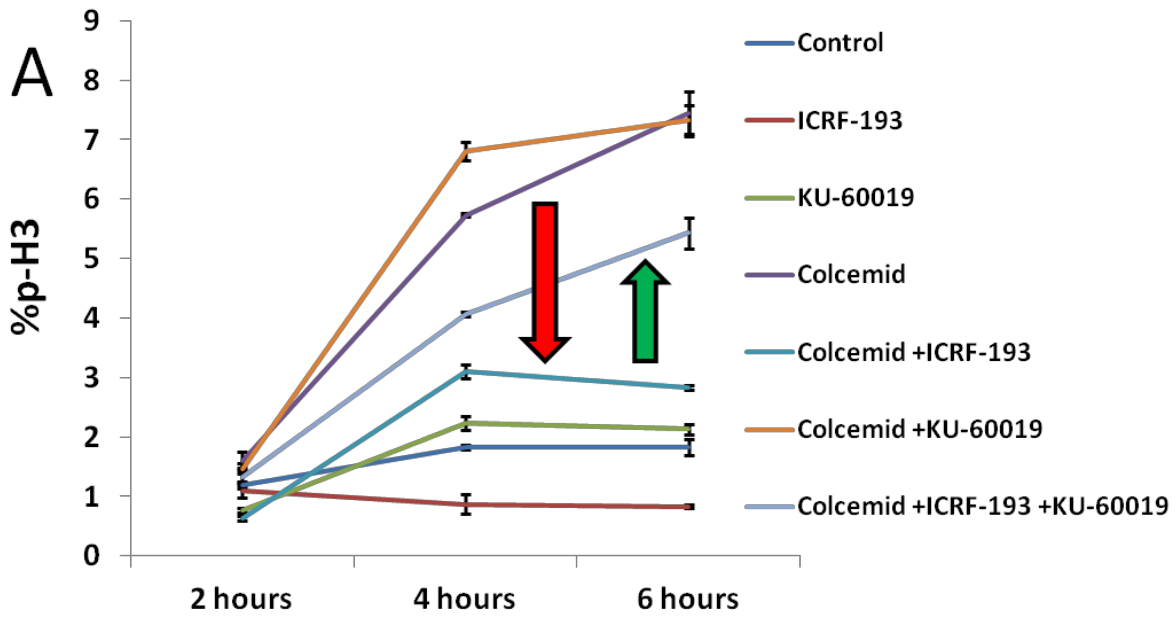

Exposure to ICRF-193 decreases slope by 2.7x ($p < 0.001$ at 4 and 6 hours)
 Inhibition of ATM increases slope by 1.9x ($p < 0.001$ at 4 and 6 hours)

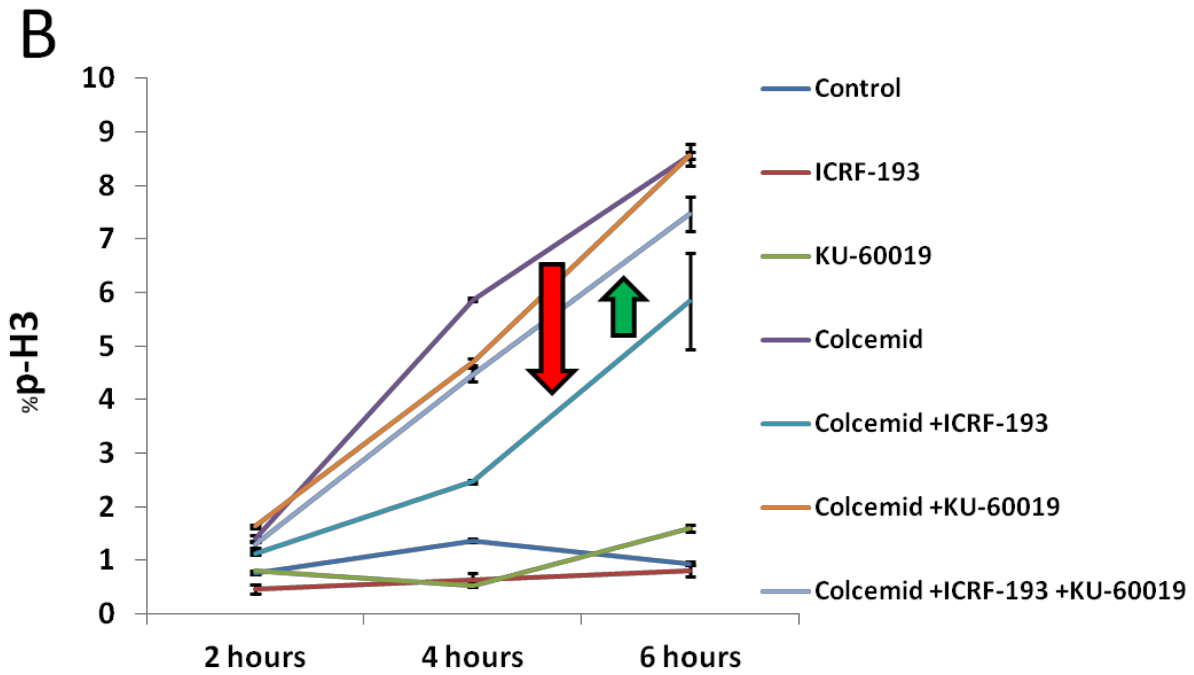

Exposure to ICRF-193 decreases slope by 1.5x ($p < 0.001$ at 4 hours)
 Inhibition of ATM increases slope by 1.3x ($p < 0.001$ at 4 hours)

Figure 3.7 – Inhibition of ATM abrogates the decatenation checkpoint and increases the mitotic entry rate.

Assayed by phospho-Histone H3 staining and flow cytometry.

(Damelin et al., 2005). "Pseudomitosis" refers to the appearance of chromosomes in mitotic spreads that have a bizarre, entangled morphology (**Figure 3.8A**). As seen in **Figure 3.8B**, we found that BG01V hES cells have a baseline pseudomitotic index of ~30%. Inhibiting ATM significantly increased the pseudomitotic index 4-fold. In addition to demonstrating ATM's importance in preventing cells from entering mitosis with tangled DNA, these results also support a previous study's finding that pluripotent cells have a deficient decatenation checkpoint, as fully differentiated cells have a pseudomitotic index of ~1% (Damelin et al., 2005).

Inhibition of ATM increases the time it takes to complete the stages of mitosis.

As described in (Beckta et al., 2012), live-cell imaging studies were conducted on BG01V cells transduced with a Histone H2B-mCherry construct. The Wahl lab has demonstrated that the H2B-fluorescent fusion protein is incorporated into nucleosomes, does not affect cell cycle progression, and permits high resolution confocal imaging of interphase chromatin and mitotic chromosomes (Kanda et al., 1998).

As our previous data demonstrates, ATM is necessary for cells to

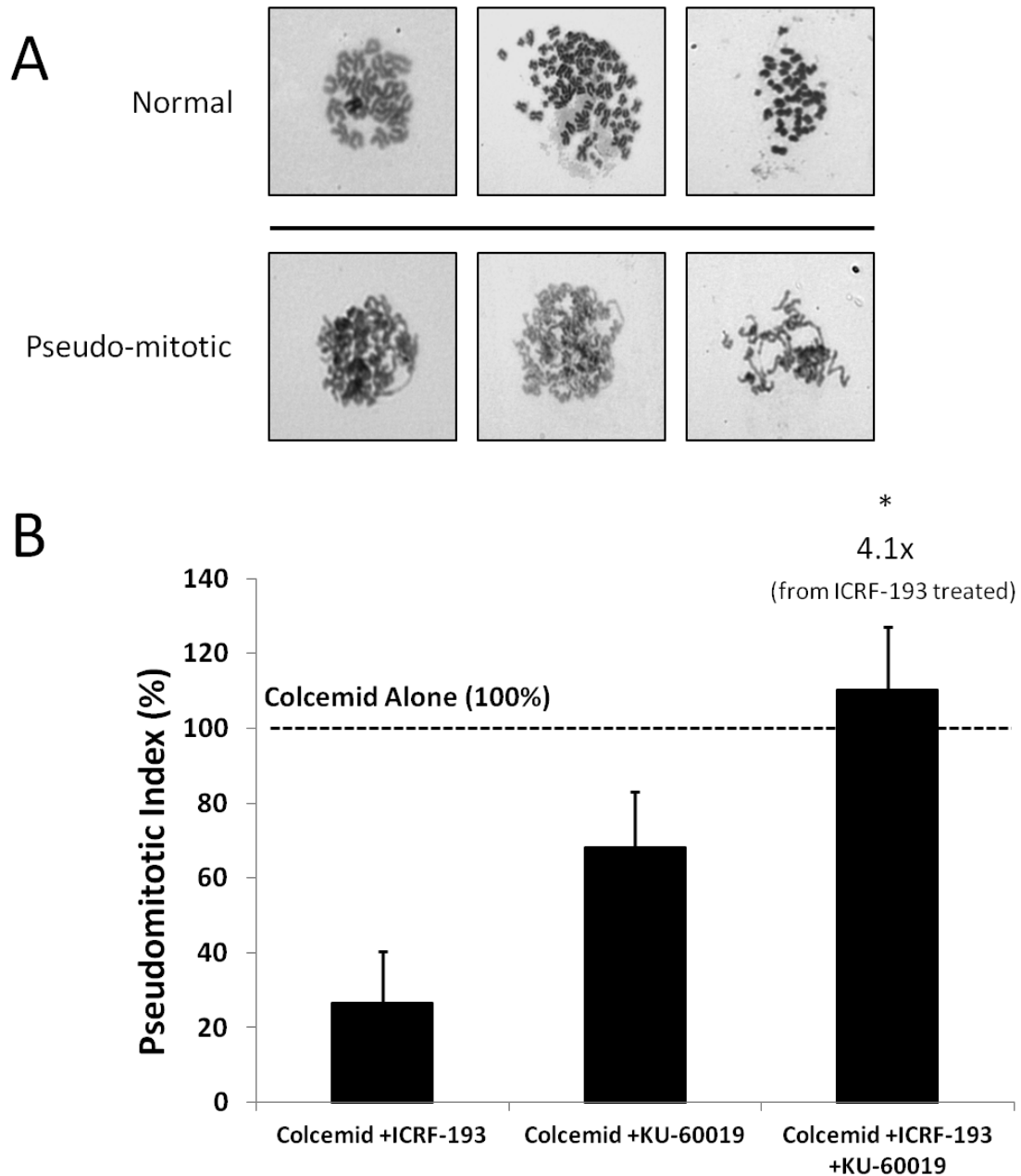

Figure 3.8 – Inhibition of ATM significantly increases the pseudomitotic index.

Assayed by mitotic spreads as described in Materials and Methods. Cells were treated with KU-60019 for 30 minutes before the addition of ICRF-193 and harvested after 4 hours.

* = $p < 0.05$

detect genetic abnormalities and prevent further cell cycle progression. We were therefore interested in investigating if inhibiting ATM prolonged the time of mitosis, with the rationale being that catenations/DNA damage would escape notice and cells would erroneously enter mitosis, "discovering" and attempting to resolve any genomic lesions while concurrently attempting to divide. As hypothesized, inhibition of ATM prolonged the time of mitosis. Addition of KU-60019 prolonged the prometaphase-to-metaphase time by 28% (**Figure 3.9A**), the metaphase-to-chromatin decondensation time by 17% (**Figure 3.9B**), and the overall time of mitosis by 21% (**Figure 3.9C**). This data demonstrates that without functional ATM, cells are still able to complete mitosis, but the increased time it takes them to do so indicates that they are either attempting to resolve undetected glitches in their DNA or proceeding to divide with these genetic flaws intact.

Inhibition of ATM causes tetraploid cell formation.

Our previous data has demonstrated the inhibiting both TopoII and ATM allows catenated cells to enter mitosis. However, the techniques used did not allow us to discern if the cells remained viable. BG01V Histone H2B-mCherry cells were exposed to various treatments and monitored via live-cell imaging for

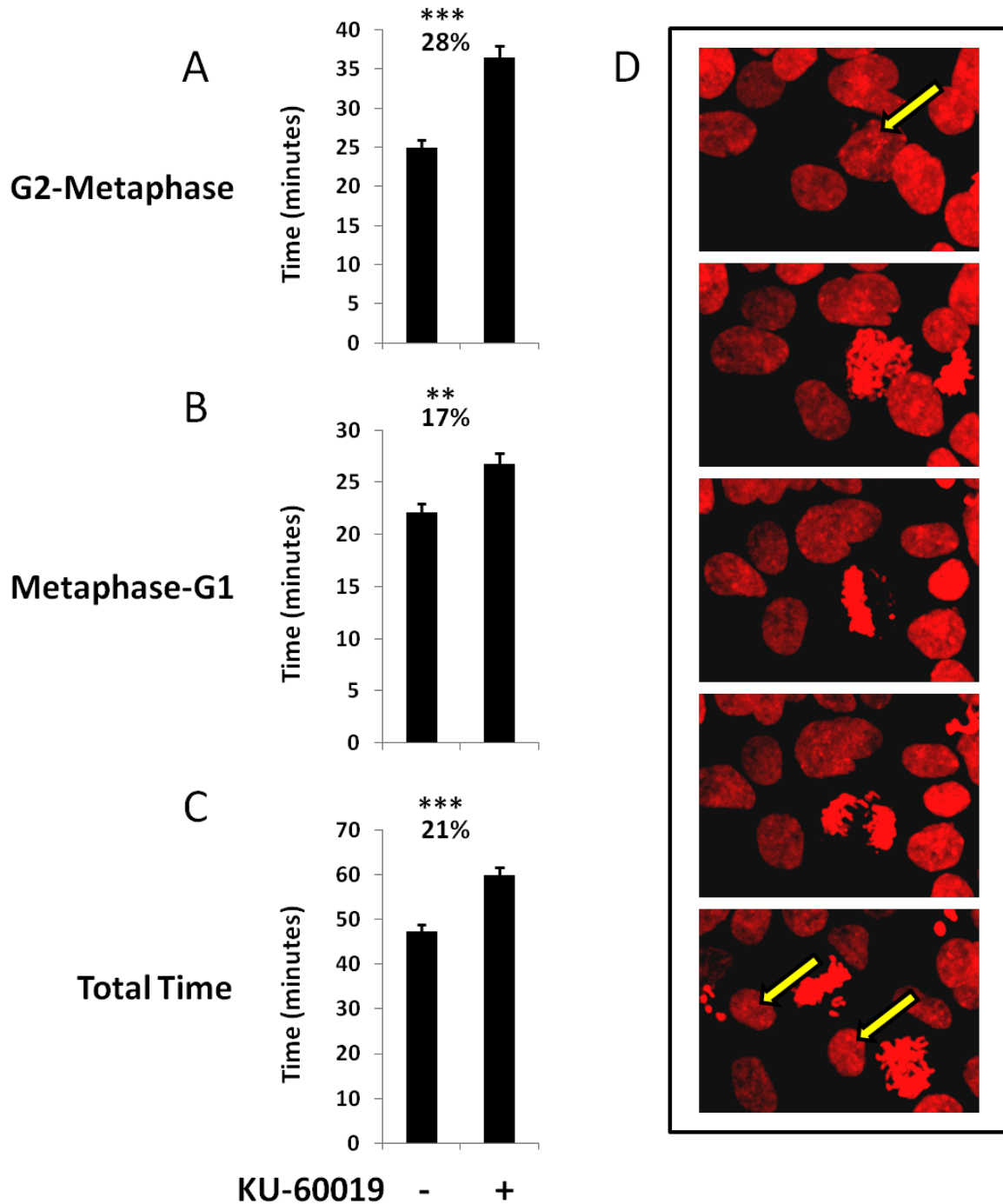

Figure 3.9 – Inhibition of ATM slows the progression through mitosis.

hESCs were transduced with an H2B-mCherry construct and mitosis was monitored using live cell imaging as described in Materials and Methods. KU-60019 was added approximately 30 minutes before recording was started. Cells were recorded for 3-4 hours.

D depicts representative images from the quantitative data presented in **A**, **B**, and **C**.

** = $p < 0.01$, *** = $p < 0.001$

several hours. Under normal conditions, BG01V cells enter mitosis at a rate of approximately 3.5% per hour (as calculated by cells demonstrating prometaphase morphology divided by the total number of cells observed). Addition of ICRF-193 reduces the mitotic entry rate by ~3 fold (**Figure 3.10A**); supporting our previous results which indicate that while exposure to ICRF-193 activates the decatenation checkpoint, this activation does not result in complete arrest. While the majority of cells remained in interphase, approximately 40% of the ICRF-193 treated cells that entered mitosis "gave up" at metaphase, decondensed their chromatin, and re-entered the cell cycle as newly minted tetraploid cells (also known as "endoreduplication") (**Figure 3.10B**). Cells were also exposed to both ICRF-193 and KU-60019, which rescued mitotic entry to near control levels (**Figure 3.10A**). As was seen in the ICRF-193-only treated cells, concurrent inhibition of ATM and decatenation caused nearly 40% of mitotic cells to become tetraploid, however, the dramatically increased mitotic entry rate meant that many more cells wound up with a gain of DNA (**Figure 10B**). This data clearly demonstrates the critical role ATM plays in preventing cells with gross changes to their DNA content from dividing.

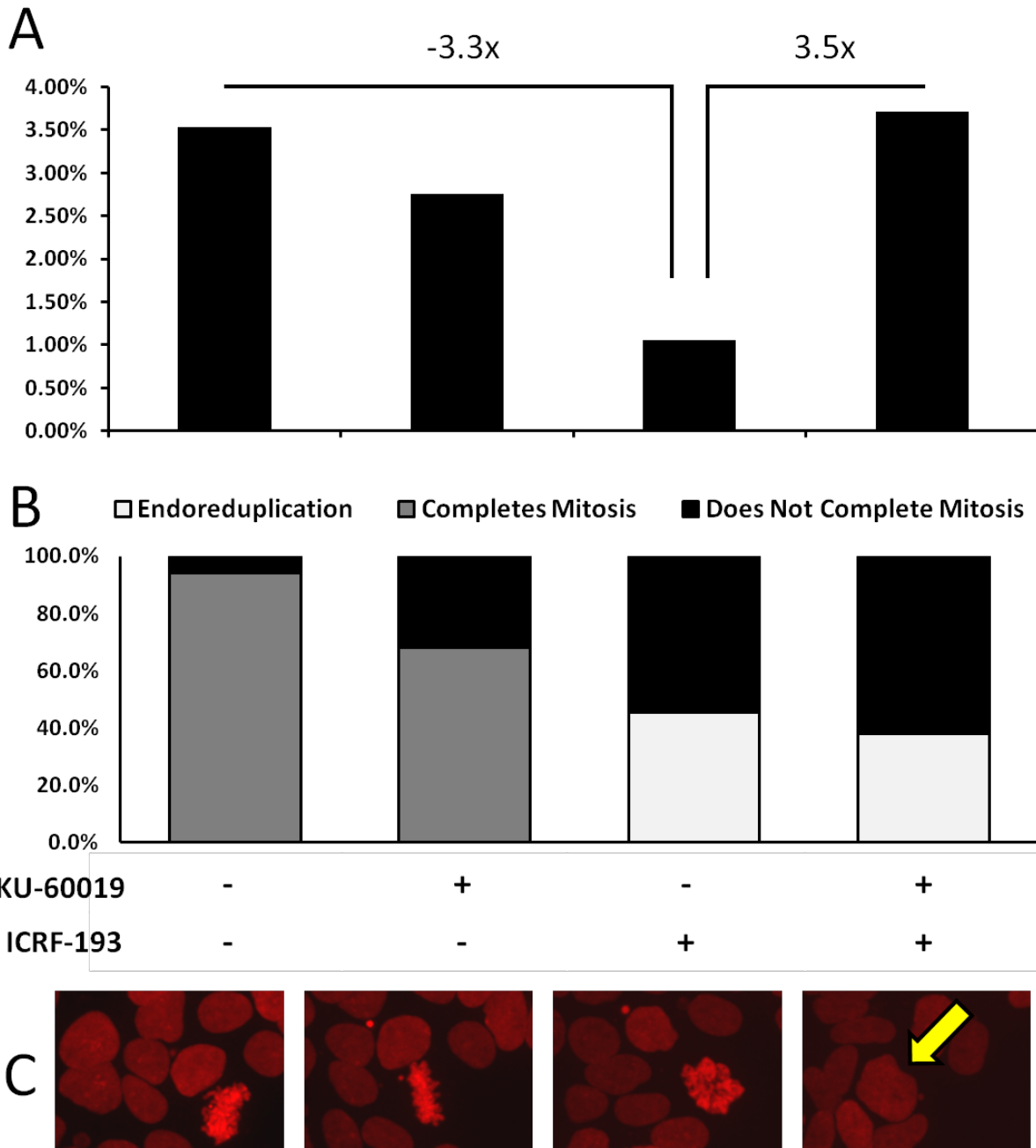

Figure 3.10 – Inhibition of ATM causes tetraploid cell formation.

A) Addition of ICRF-193 drastically reduces the percentage of cells entering mitosis per hour, inhibition of ATM reverses this effect. B) Cells treated with ICRF-193 undergo endoreduplication, concurrent treatment with KU-60019 greatly enhances this effect. C) Representative example of the live-cell imaging data presented in **Figure B**.

Inhibition of ATM causes aneuploidy.

The previous data indicated that cells with enormous genomic errors could survive and propagate if ATM was inhibited. We were therefore interested in uncovering what changes prolonged pharmacologic inhibition of ATM would cause in hESCs. H9 cells were exposed to KU-60019 for 24 hours, fixed immediately, and stained for CREST and Cyclin A. Kinetochores (revealed via CREST staining) were compared between control and KU-60019 treated cells. Cyclin A positive cells (representing S and G2 phase cells) were excluded in the analysis. 24 hours of ATM inhibition significantly increased the number of kinetochores counted per cell (**Figure 3.11A**), indicating that these cells gained DNA. Additionally, H9 cells were exposed to KU-60019 for 24 hours, then media was replaced and cells were allowed to grow for 24 hours with no treatment, after which time the cells were fixed and stained with CREST and Cyclin A. While there was still a significant increase in the number of kinetochores per cell after ATM inhibition, the 24 hour washout period allowed cells to trend back to control levels (**Figure 3.11B**), suggesting that once ATM inhibition is relieved aneuploid cells are removed from the population (either via apoptosis or necrosis).

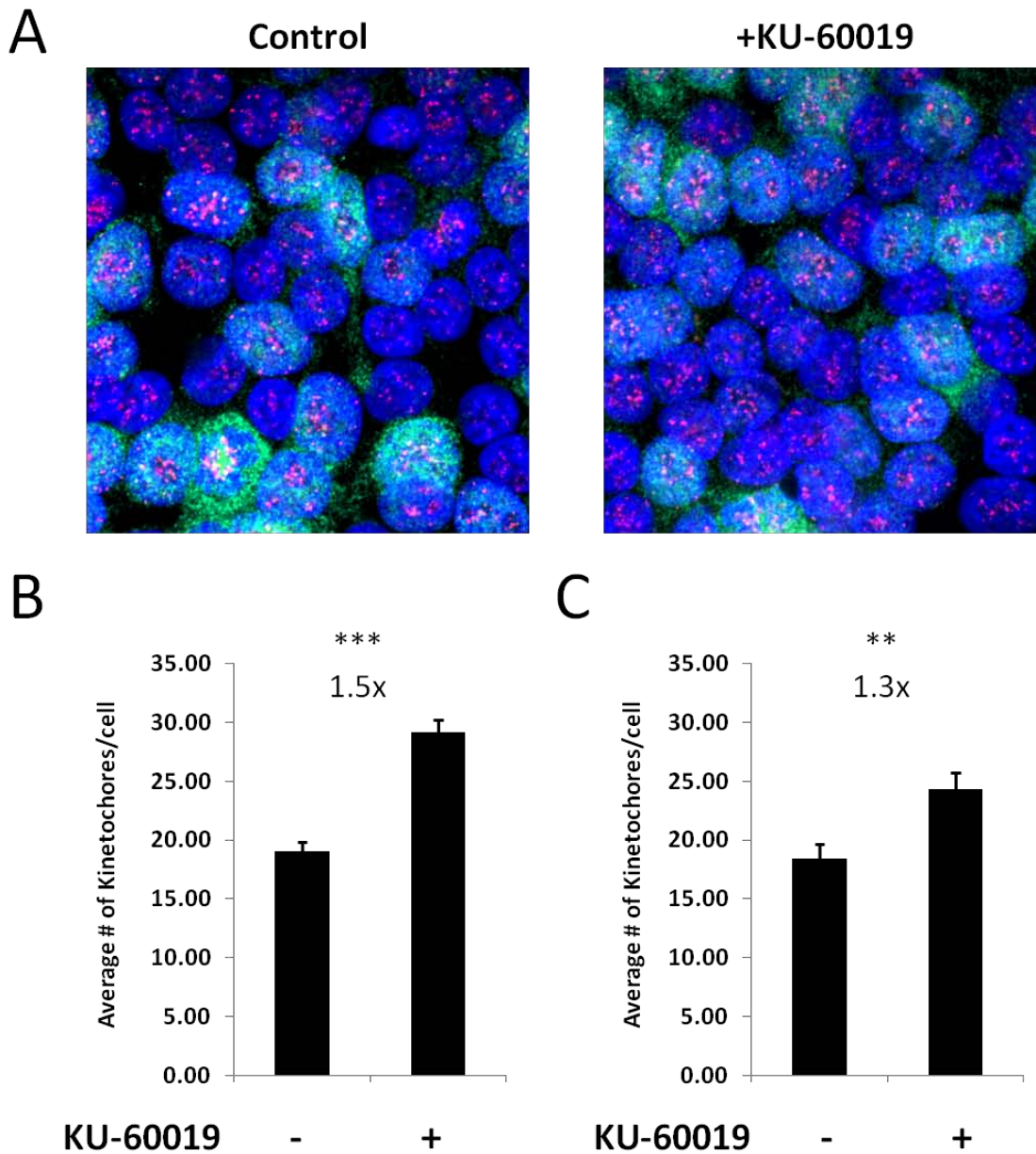

Figure 3.11 – Inhibition of ATM causes aneuploidy.

B) Inhibition of ATM for 24 hours causes an increase in kinetochore staining, indicating a gain of DNA content. **C)** Inhibition of ATM for 24 hours followed by a 24 hour washout begins to reverse this effect, but DNA content is still significantly elevated. **A)** Representative images of the quantitative data presented **B** and **C**.

Blue = DAPI, Red = kinetochores, Green = Cyclin A

** = $p < 0.01$, *** = $p < 0.001$

Chapter Summary

Crucial to the development of therapeutics based on hESCs is an understanding of how they maintain genomic stability. Previous work in our lab has shown that while ATM is present and active in hESCs, it is not performing its canonical role in the DNA damage response. However, ATM is a key part of innumerable cellular signaling pathways that are important in the maintenance of genomic integrity. In order to elucidate ATM's role in hESCs, we turned our attention to the G2/M decatenation and DNA damage checkpoints. Our current understanding of hESC cell cycle regulation suggests that these cells spend a very short time in G1 and lack a stringent G1/S checkpoint. This makes the enforcement of a G2/M checkpoint tremendously critical in hESCs. In this chapter, I have demonstrated that ATM is crucial for enacting the G2/M checkpoint(s) and preventing the generation of aneuploid cells.

The data presented here shows that catalytic inhibition of TopoII activates ATM and causes cells to arrest in G2. While there is disparity in the literature, the activation of ATM in response to decatenation inhibition is consistent with other reports. Our studies used the highly effective ATM inhibitor, KU-60019. Our lab has previously shown KU-60019 to be

significantly more effective than KU-55933, the drug used in the only other study examining ATM's role in hESC G2/M arrest (Momcilović et al., 2009). As seen in **Figures 2 and 3**, KU-60019 is able to block the activation of ATM in hESCs at a dose of 3 μ M. However, there appears to be residual levels of p-ATM still present even after KU treatment. This is a phenomenon we have encountered before, and it has been shown that p-S1981 ATM antibody we use has the capacity to recognize multiple substrates (Matsuoka et al., 2007a). The background levels represent other activated members of the DNA damage response, either due to the ICRF-193 treatment or other cellular activities.

We turned to live-cell imaging to record what is happening with ATM inhibition on a cell-by-cell basis. A previous report has shown that certain stages of mitosis were prolonged in MEFs with both ATM and p21 knocked out (Shen et al., 2005). This is of interest to our studies, as hESCs have low levels of p21 (see **Chapter 1**), so the results obtained with the use of an ATM inhibitor in a p21-negative background should be similar. However, these generalizations are hard to make. First, as with the other reports investigating ATM's role in cell cycle regulation, there are significant species and lineage differences between stem cell populations. MEFs are both non-

human and lack pluripotency. Additionally, use of cells with permanently knocked out proteins can encourage the cell to adapt and use other proteins/pathways. Here, we show for the first time that transient inhibition of ATM in hESCs is enough to significantly perturb the progression through mitosis. We hypothesize that this is potentially due to two reasons: first, ATM inhibition renders the cell unable to sense genomic insults and resolve them before entering mitosis. The cell must then deal with these issues as they interfere with the process of mitosis. Second, a recent manuscript has been published showing that ATM is important for the progression through mitosis via its signaling activity at the spindle assembly checkpoint (Yang et al., 2011). While this study was not done in pluripotent cells, ATM could potentially be playing a similar role in hESCs, causing an increase in the time of mitosis.

Finally, we demonstrate that inhibiting ATM for as little as 24 hours causes a significant increase in kinetochore staining, indicating a gain of DNA content. When cells were allowed to have a 24-hour washout period, kinetochore staining was still significantly increased, but trending back towards control levels. This suggests that the aneuploid cells, once ATM inhibition was released, undergo some type of cell death. Of note, the control groups only averaged around 19 kinetochores

per cell, instead of the expected 46. This is likely to be caused by the spatial relationships of the kinetochores in the nucleus. If CREST antigens are too close together (either in the X/Y or Z planes) then these foci will merge together and appear as one, larger foci. It would be virtually impossible to tease these groupings out using confocal imaging. Future studies using assays such as fluorescent in situ hybridization (FISH) could be employed to obtain a more accurate measurement of changes in DNA content.

In summary, the experiments presented in this chapter have shown that ATM is important for G2/M cell cycle arrest, either due to DNA damage or inhibition of decatenation, in hESCs. At the same time, these experiments show that hESCs have a relatively weak decatenation checkpoint. Live-cell imaging studies have revealed that inhibition of ATM allows cells with substantially tangled DNA to attempt mitosis, and, when that attempt fails, to resume cycling as tetraploid cells. Importantly, experimental results have directly demonstrated that prolonged inhibition of ATM causes aneuploidy, and release from ATM inhibition reduces this effect. Taken together, these observations establish the importance of ATM in maintaining the genomic stability of hESCs.

Chapter 4:

ATM, BRCA1, and Aurora A: How to Arrest a Cell

Introduction

The mechanisms by which ATM could enact a G2/M arrest are numerous. A large-scale substrate analysis has identified more than 700 possible (and confirmed) targets of ATM (Matsuoka et al., 2007b), and, as is the case when studying globally-acting proteins, many of these targets play some sort of role in cell cycle regulation. Some of the early research into the decatenation checkpoint found evidence that the protein Plk1 (polo-like kinase 1) is involved in checkpoint activation (Luo et al., 2009), and other studies have found that Plk1 is regulated by ATM in response to DNA damage (see (van Vugt et al., 2001), for example). Additionally, as Plk1 is regulated upstream by Aurora A, we decided to start the search for a mechanism in the Aurora A/Plk1 signaling pathway.

Through exploring the literature for possible intersections between ATM and G2/M regulation pathways, we uncovered a little-studied interaction between BRCA1 (a well-described target of ATM) and Aurora A. In 2004, a group working out of the Mt. Sinai School of Medicine published a report in which they present evidence showing that Aurora A binds to and phosphorylates BRCA1, and that this interaction is important for promoting the G2/M transition (Ouchi et al., 2004). Importantly, they showed

that Aurora A binds to BRCA1 in the amino acid region 1314-1863, which spans the SQ cluster domain where ATM exerts its kinase activity. By creating a mutant version of BRCA1 that was non-phosphorylatable by Aurora A (S308N mutation), Ouchi and colleagues found that these cells were unable to enter mitosis, indicating that this small post translational modification of BRCA1 had major cell cycle consequences.

Subsequent studies from the Parvin laboratory found that the phosphorylation of BRCA1 by Aurora A inhibited BRCA1's E3 ubiquitin ligase activity (Sankaran et al., 2005). BRCA1 functions at centrosomes to 1) prevent centrosome amplification and 2) prevent microtubule nucleation. This second function, the inhibition of microtubule nucleation, is a conundrum. BRCA1 localization to the centrosomes peaks during M phase, when microtubule nucleation activity is highest (Sankaran et al., 2005). How is this seemingly contradictory information rectified? Sankaran *et al* found that Aurora A, by binding to and phosphorylating BRCA1, inhibits the ubiquitin-mediated inhibition, thus allowing appropriate formation of microtubules (Sankaran et al., 2005). It appears likely that BRCA1 targets centrosomes initially during S phase to prevent over-amplification, and remains there in M phase, phosphorylated and inactive, except in the case of DNA damage. An independent

laboratory found that functional BRCA1 and Aurora A was necessary to prevent centrosome over-amplification after DNA damage (Brodie and Henderson, 2012). These studies suggest that BRCA1 remains localized to centrosomes as a fail-safe in the event that DNA damage is experienced and cycling needs to be halted.

As activated ATM phosphorylates BRCA1 at several serine residues in the amino acid region in which Aurora A binds, and Aurora A binding/phosphorylation is necessary to inhibit BRCA1's inhibition of microtubules (allowing the transition into mitosis), we hypothesize that ATM's phosphorylation of BRCA1 disrupts Aurora A binding. This disruption means that BRCA1 continues to inhibit microtubules, and provides one plausible mechanism by which ATM activation turns on the G2/M checkpoint in response to DNA damage and/or tangled chromosomes.

Materials and Methods

Antibodies, reagents, and irradiation:

Antibodies used were anti-Aurora A (1:1000 WB, 1:500 ICC) (Cell Signaling Technologies), -p-Aurora A (1:1000 WB, 1:500 ICC) (Cell Signaling Technologies), -BRCA1 (Ab-1, Ab-4) (1:1000 WB, 1:100 ICC) (Calbiochem), BRCA1 (C-20) (2 µg IP) (Santa Cruz Biotechnologies), -p-S1423-BRCA1 (1:1000 WB, 1:500 ICC) (Santa Cruz Biotechnologies), and -p-S308-BRCA1 (1:1000 WB) (kindly provided by Toru Ouchi). KU-60019 (provided by KuDOS Pharmaceuticals, Inc.) was dissolved in DMSO and used at a concentration of 3 µM. Nocodazole (Sigma-Aldrich) was dissolved in DMSO and used at a concentration of 100 nM. Irradiations were performed using a MDS Nordion Gammacell 40 research irradiator with a Cs-137 source delivering an approximate dose of 1.05 Gy/min.

Cell culture:

The hESCs BG01V (ATCC, Rockville, MD) and H9 (Thomson et al., 1998) were maintained as described in **Chapter 3**. Experiments were performed 24-48 hours after passaging, except in the case of immunoprecipitation reactions, where experiments were performed once cells became nearly confluent in a 10cm dish

(totaling 0.75 - 1 milligrams of protein).

Western blotting:

Western blotting was performed as described in **Chapter 3**.

Confocal imaging:

Confocal imaging was performed as described in **Chapter 3**. For co-localization experiments depicting cells in prometaphase, hESCs were fixed and assayed after 4 hours of nocodazole treatment. hESCs assayed for mitotic index were also fixed after 4 hours of nocodazole treatment.

Transfection:

Generation of wild-type BRCA1 plasmid:

pcDNA3(*Bss*HII)-HA-3XFLAG-BRCA1 wild-type was generated as described in (Dever et al., 2011).

Generation of 4P BRCA1 mutant plasmid:

First, plasmid pcDNA3 (*Bss*HII)-HA-3XFLAG-BRCA1 S1387/1423A was generated from plasmid pcDNA3-HA-BRCA1 S1387/1423A (kindly provided by Bo Xu) by swapping the *Bam*HI *Xho*I fragments with pcDNA3 (*Bss*HII)-HA-3XFLAG-BRCA1 wild-type. The S1387/1423/1457/1524A quadruple mutant was then generated from plasmid pcDNA3(*Bss*HII)-HA-3XFLAG-BRCA1 S1387/1423A by sequential

rounds of QuikChange site-directed mutagenesis (Stratagene) using primers GCAGTATTAAGTGCACAGAAAAGTAGTG and CACTACTTTTCTGTGCAGTTAATACTGC to create the S1457A mutation and primers GAATAGAACTACCCAGCTCAAGAGGAGCTC and GAGCTCCTCTTGAGCTGGGTAGTTTCTATTC to create the S1524A mutation.

Transfection procedure:

Transfections were performed using Qiagen's SuperFect and their recommended protocol. In brief, 10 µg of plasmid DNA (in 5 µL of water) was complexed with 10 µL of SuperFect. DNA/SuperFect complex was incubated with cells for 3 hours, after which the cells were washed 1x in PBS. Assays were conducted ~48 hours after transfection.

Immunoprecipitation and co-immunoprecipitation:

Cells were lysed in a modified RIPA buffer (1% NP-40, 150 mM NaCl, 50 mM HEPES, HALT™ protease and phosphatase) or MPER buffer (Thermo Scientific Pierce). Protein levels were measured to be ~750 µg. For BRCA1 immunoprecipitation, 5 µg of BRCA1 C-20 antibody was added to each lysate, and the samples were allowed to incubate overnight at 4°. For p-BRCA1/Aurora A co-immunoprecipitation, 5 µg of p-S1423-BRCA1 was used. 50 µL of Dynabeads (Invitrogen) were added the following morning and incubated for an additional 2 hours at 4°. The samples were

washed three times in ice-cold PBS, mixed with Laemlli buffer + β -mercaptoethanol, and boiled for 10 minutes. The lysates were then loaded onto a Criterion™ TGX gel and run as earlier described. To minimize noise from the IgG heavy chain, blots were incubated with light chain specific secondary antibodies (Jackson Immuno) at 1:600 and developed on a GelDoc (Bio-Rad Laboratories) imaging system.

λ -phosphatase assay:

Lysates were immunoprecipitated as previously described using the BRCA1 C-20 antibody. Lambda Protein Phosphatase (New England BioLabs) was used per manufacturer's protocols. In brief, samples were incubated with ~1,200 units of λ -phosphatase for 1 hour at 30 °, after which time laemlli buffer was added and samples were boiled for 10 minutes.

Statistics:

T-test was performed using GraphPad Prism 3.0 (GraphPad Software, Inc). P value is indicated as ***, 0.001.

Results

ATM phosphorylates BRCA1 in response to DNA damage.

As discussed in Chapter 2, ATM directly phosphorylates BRCA1 in the SQ domain in response to DNA damage. While this has been demonstrated in multiple studies since it was first discovered, no one has examined if this phenomenon occurs in hESCs. First, hESCs were treated with or without KU-60019 for 30 minutes prior to exposure to 5 Gy IR. Cells were allowed to incubate for 1 hour before lysates were harvested for western blot analysis. As seen in **Figure 4.1A**, there is a high basal level of p-S1423-BRCA1 in control and KU-60019-alone treated cells. Treatment with IR caused a 1.6-fold increase in p-BRCA1 levels, while concurrent treatment with KU-60019 prevented this increase. These results indicate (in line with the literature) that ATM phosphorylates BRCA1 in response to DNA damage in hESCs.

Unexpectedly, these results indicate that hESCs contain a high endogenous level of p-BRCA1, even in the absence of any overt DNA-damaging treatment. Additionally, inhibition of ATM, while preventing the increase in p-BRCA1 levels, does not do much to alleviate this phosphorylation (see **Figure 4.1A**, untreated vs. KU-60019 treated lanes). These results could indicate two

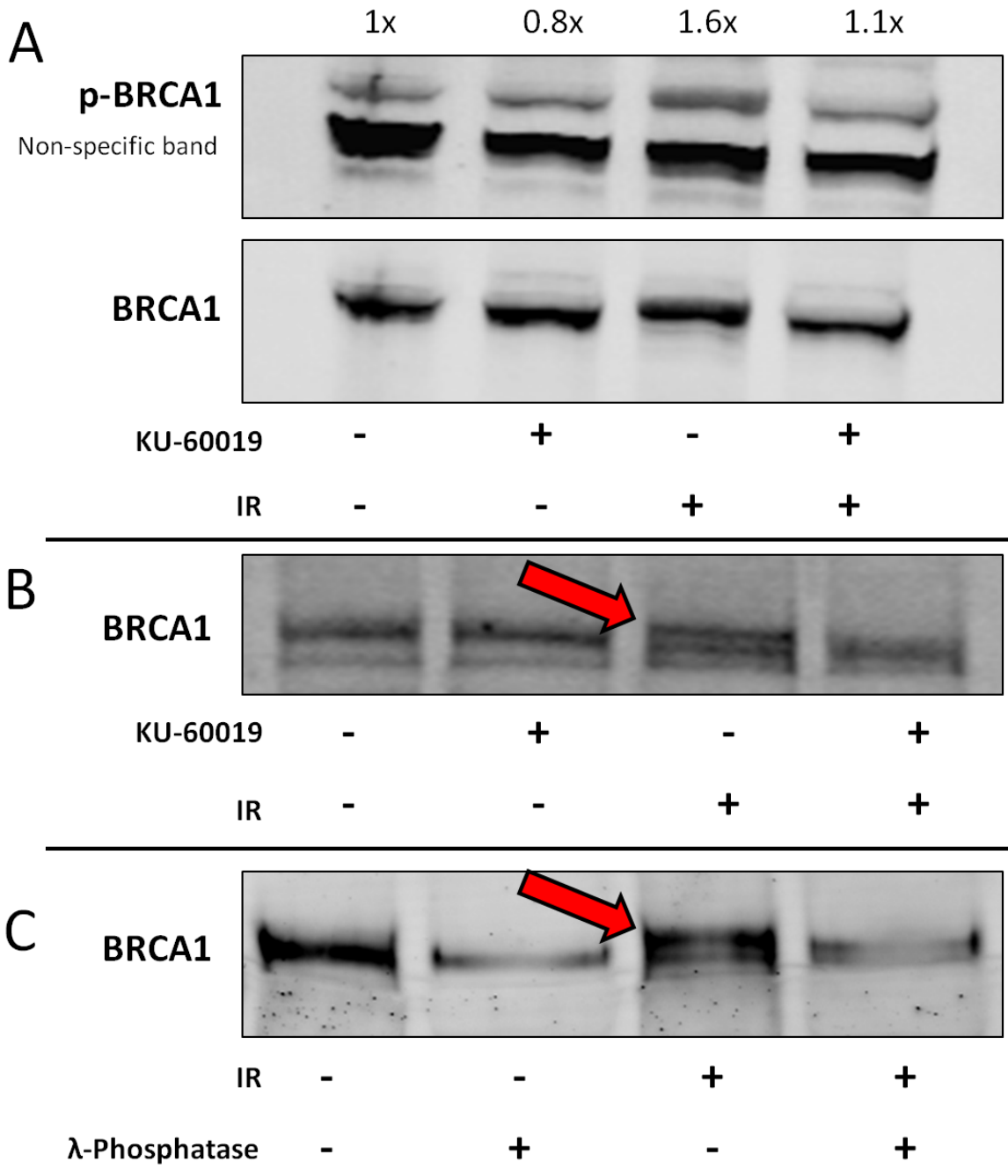

Figure 4.1 – ATM phosphorylates BRCA1 in response to DNA damage.

A) Exposure of hESCs to 5 Gy IR causes an increase in p-S1423-BRCA1. Inhibition of ATM abrogates this effect. **B)** 5 Gy IR causes a gel shift of BRCA1 to a “heavier” position. Inhibition of ATM abrogates this effect, indicating extensive phosphorylation by ATM. **C)** Treatment of BRCA1 IP samples with λ-Phosphatase reverses the gel shift effect caused by IR, indicating the decrease in mobility is due to extensive phosphorylation.

distinct possibilities: 1) the p-S1423-BRCA1 antibody used is recognizing un-phosphorylated BRCA1, or, 2) hESCs, for whatever reason, function with an unanticipatedly high amount of p-BRCA1. The original manuscripts describing ATM's phosphorylation of BRCA1 used gel-shift assays to determine how these two proteins interact (in lieu of having p-BRCA1-specific antibodies). Therefore, to clarify which of the two possible events is occurring here, endogenous BRCA1 was immunoprecipitated from hESC lysates treated with or without IR and/or KU-60019. Samples were then run out on a 7.5% gel for an extended period of time to separate different molecular weight versions of BRCA1. As seen in **Figure 4.1B**, control and KU-60019-treated cells stain for two distinct versions of BRCA1. When treated with IR, a third species develops, which disappears with concurrent ATM inhibition. It appears that hESCs have three "versions" of BRCA1, with varying amounts of post-translational modifications. There appears to be a relatively constant amount of the highest-mobility BRCA1 version throughout all groups. The middle-weight band varies based on treatment, remaining fairly similar between control and KU-60019-treated cells, while diminishing with exposure to IR. It seems that the third, most heavily modified band is generated using the middle-weight band as a substrate. While it is presumed that the ATM-mediated post-translation modification of BRCA1 is chiefly phosphorylation, this is not

guaranteed. Therefore, hESCs were treated with or without IR, harvested, and immunoprecipitated for endogenous BRCA1. Extracts were then exposed to λ -phosphatase, a Mn^{2+} -dependent protein phosphatase which removes phosphorylations from serine, threonine, and tyrosine residues. As seen in **Figure 4.1C**, exposure to IR induces the appearance of three different BRCA1 species, while λ -phosphatase treatment reverses this effect. Collectively, these results indicate that BRCA1 is extensively phosphorylated by ATM in response to DNA damage, and ATM inhibition prevents this phosphorylation. However, it appears that at least one other kinase (possibly ATR (Gatei et al., 2001)) is still acting extensively in BRCA1's SQ cluster domain, regardless of treatment. Which protein is responsible and what purpose this continuous phosphorylation serves remains unclear.

BRCA1 and Aurora A co-localize during mitosis.

Previous reports have indicated that BRCA1 interacts with Aurora A, and that this interaction is important for the entry into mitosis (Ouchi et al., 2004). To investigate if this occurs in hESCs, cells were grown on chamber slides, fixed, and stained for BRCA1 and p-Aurora A. **Figure 4.2A** shows BRCA1 and Aurora A co-localize in prometaphase, while **Figure 4.2B** demonstrates this interaction in metaphase. This co-localization was not witnessed

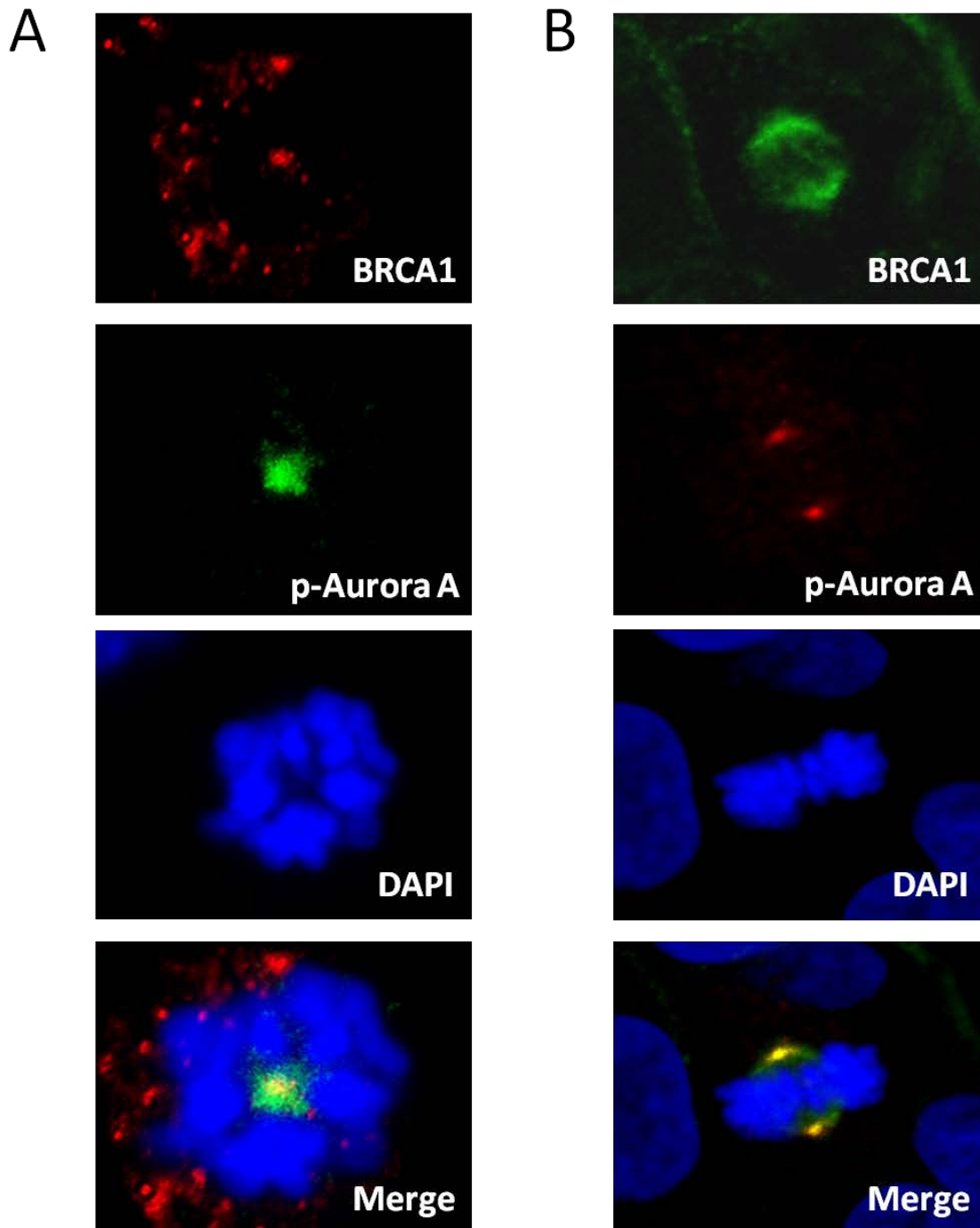

Figure 4.2 – BRCA1 and Aurora A co-localize during mitosis.

A) BRCA1 and p-T288-Aurora A co-localize during prometaphase and **B)** BRCA1 and p-Aurora A co-localize during metaphase, two stages of mitosis where regulation of microtubule formation is most critical.

in any other phase of the cell cycle, in fact, little to no Aurora A staining (either total or phospho) was recorded outside of mitosis. This is likely because Aurora A is expressed at low levels during interphase, peaks at G2/M, and is degraded at the end of mitosis (Tanaka et al., 2002; Vader and Lens, 2008).

Activation of ATM blocks the interaction of BRCA1 and Aurora A. Treatment with KU-60019 reverses this effect.

Previous work has yielded data that shows Aurora A binding to the region of BRCA1 in which the SQ cluster domain resides, and that this binding is necessary for the S308-BRCA1 phosphorylation which promotes the transition into mitosis (Ouchi et al., 2004). We hypothesized that activated ATM phosphorylates BRCA1's SQ cluster domain and disrupts this interaction, and that this disruption is one mechanism by which ATM arrests cells at the G2/M border. However, repeated attempts at co-immunoprecipitating Aurora A with endogenous BRCA1 were unsuccessful, regardless of treatment (a similar amount of Aurora A always came down with BRCA1) (data not shown). Since hESCs seem to contain high levels of p-BRCA1 (**Figure 4.1**), we decided to use the p-S1423-BRCA1 antibody for both immunocytochemistry co-localization and western blot co-immunoprecipitation experiments. **Figure 4.3A** shows p-BRCA1 co-

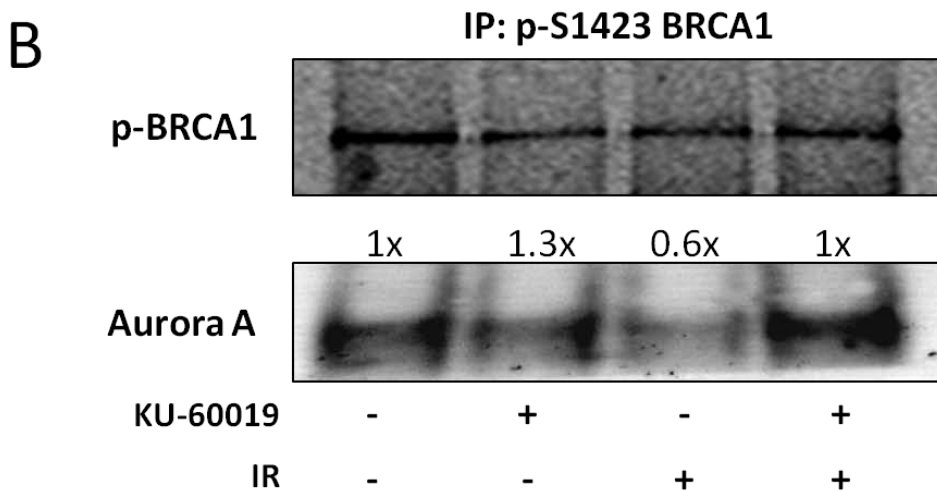
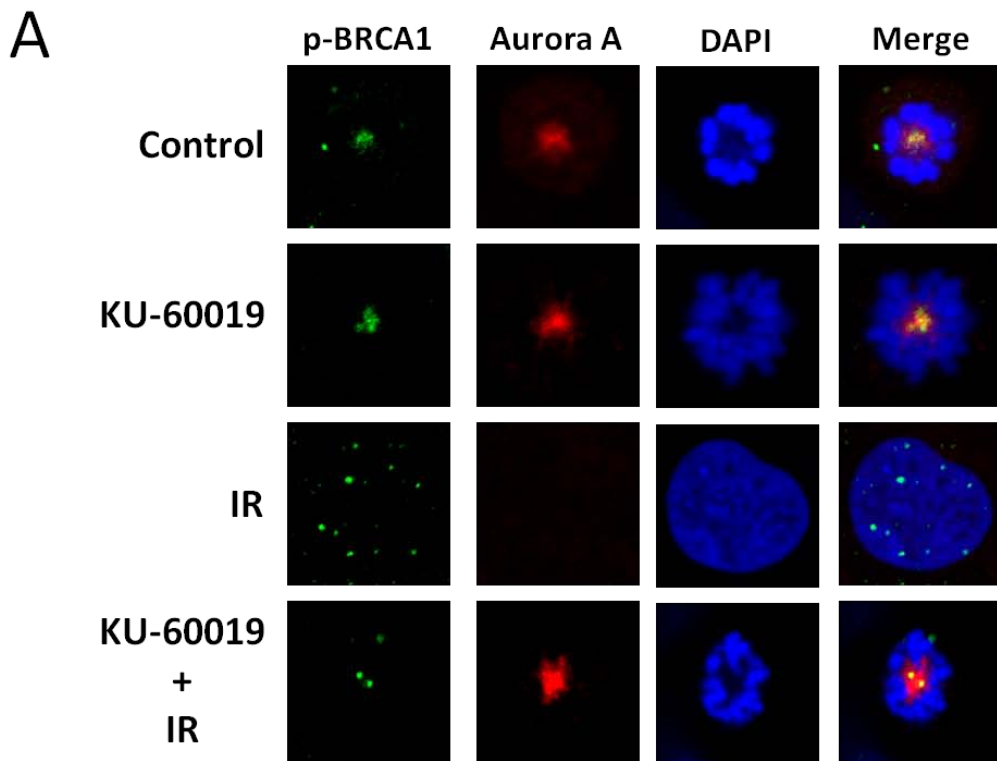

Figure 4.3 – Activation of ATM blocks the interaction of BRCA1 and Aurora A. Treatment with KU-60019 reverses this effect.

A) p-BRCA1 and Aurora A co-localize during mitosis, IR blocks this interaction. Inhibition of ATM restores co-localization. **B)** Aurora A co-immunoprecipitates with p-BRCA1. IR blocks this interaction, which is restored upon ATM inhibition. Fold changes are normalized against the amount of p-BRCA1 pulled down.

localizing with Aurora A in control and KU-60019 treated cells. In IR-treated cells, this interaction disappears, although most nuclei demonstrated p-BRCA1 foci (presumably indicating areas of DNA damage). When cells were irradiated under ATM inhibition, the BRCA1/Aurora A co-localization was restored.

The same trend was seen with endogenous p-BRCA1 co-immunoprecipitation experiments. As demonstrated in **Figure 4.3B**, a similar amount of Aurora A was immunoprecipitated along with p-BRCA1 in control and KU-60019-treated lysates (1x and 1.3x, respectively, when normalized for total amount of p-BRCA1). Treatment with 5 Gy IR dramatically reduced the amount of Aurora A pulled down, while treatment with both KU-60019 and IR restored the BRCA1/Aurora A interaction. Collectively, these results indicate that BRCA1 and Aurora-A interact in hESCs, and that ATM activation disrupts this relationship.

IR decreases Aurora A-mediated phosphorylation of S308-BRCA1.

Concurrent inhibition of ATM reverses this effect.

The interaction between BRCA1 and Aurora A results in Aurora A phosphorylating BRCA1 at Serine 308, and this post-translation modification is important for mitotic entry regulation (Ouchi et al., 2004). This result has been independently validated and

experimental results have also shown that BRCA1 phosphorylation by Aurora A is important for BRCA1's retention at centrosomes (Brodie and Henderson, 2012) as well as its regulation of mitotic microtubule nucleation (Sankaran et al., 2005). Therefore, it is likely that by disrupting the interaction of BRCA1 and Aurora A, ATM is preventing Aurora A from phosphorylating BRCA1. To test this hypothesis, we first immunoprecipitated endogenous BRCA1 from hESC lysates that were treated the same way as in previous experiments (with or without KU-60019 and/or 5 Gy IR). As shown in **Figure 4.4**, the DNA damage caused by IR drastically reduced the amount of p-S308-BRCA1. This effect was reversed by ATM inhibition, indicating that ATM activation not only disrupts the BRCA1/Aurora A interaction, it also prevents the BRCA1 serine phosphorylation that is important for mitotic regulation and entry.

Expression of a non-phosphorylatable BRCA1 mutant mimics the ATM-inhibited phenotype.

In order to corroborate the results obtained with the pharmacologic inhibition of ATM, we created a FLAG-tagged mutant version of BRCA1 in which four critical serine residues (targets of both ATM and ATR) are mutated to alanine (referred to as the "4P" mutant) (see **Figure 4.5** for a schematic of the plasmids

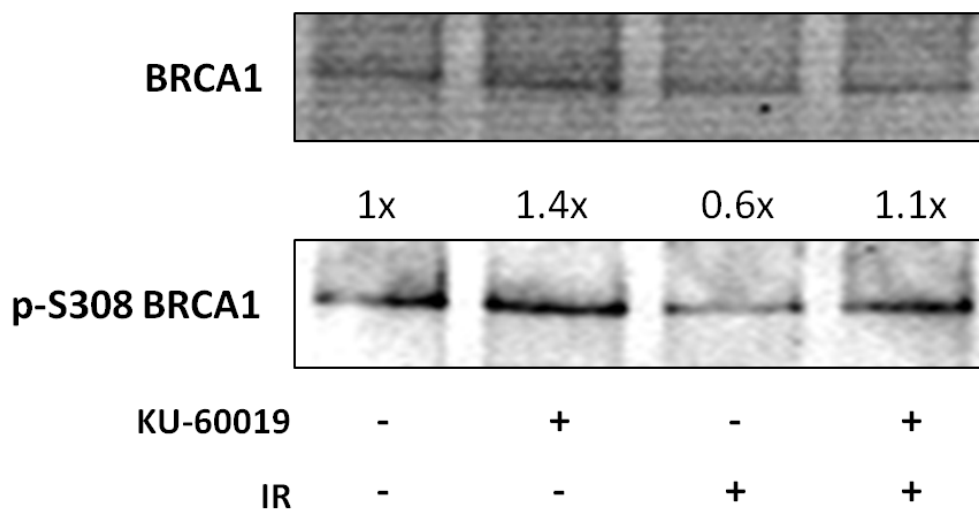

Figure 4.4 – IR decreases Aurora A-mediated phosphorylation of S308-BRCA1. Concurrent inhibition of ATM reverses this effect.

Lysates were subject to immunoprecipitation with a BRCA1 antibody as described in the Materials and Methods. The resulting blot was then probed for both total BRCA1 and p-S308 BRCA1. Fold changes are normalized against total amount of BRCA1 that was immunoprecipitated.

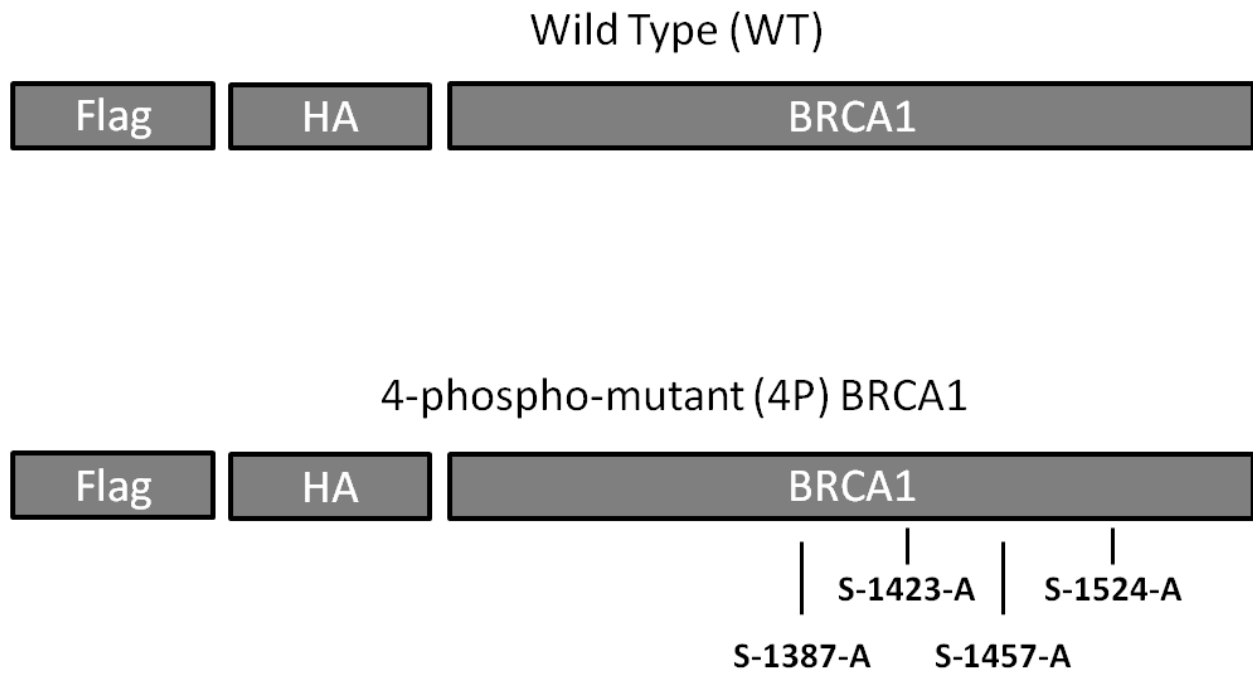

Figure 4.5 – Schematic of WT and 4P BRCA1 constructs.
 Constructs were derived as described in Materials and Methods.

used). If our hypothesis is correct, and the extensive phosphorylation of the SQ cluster of BRCA1 prevents the entry into mitosis, then cells transfected with the 4P mutant should display defects in cell cycle arrest. Both FLAG-tagged wild type (WT) BRCA1 and the 4P mutant were transfected into 293T cells to check for expression. Once it was confirmed that the plasmids translated and transcribed appropriately (**Figure 4.6A**), they were transfected into hESCs using SuperFect. In un-irradiated cells, the 4P-mutant cells had a higher (though not significant) mitotic index than the WT cells. However, after 5 Gy IR, 4P cells had a significantly higher mitotic index when compared to WT cells (an almost 4-fold increase) (**Figure 4.6B**).

Interestingly, the 4P cells (both control and irradiated) demonstrated an obvious reduction in cell number, indicating the serine-to-alanine mutations were somewhat toxic to the cells. Presumably, the high basal levels of p-BRCA1 in hESCs somehow promotes survival, either through enhanced DNA repair, more efficient cell cycle checkpoints, or some combination of the two.

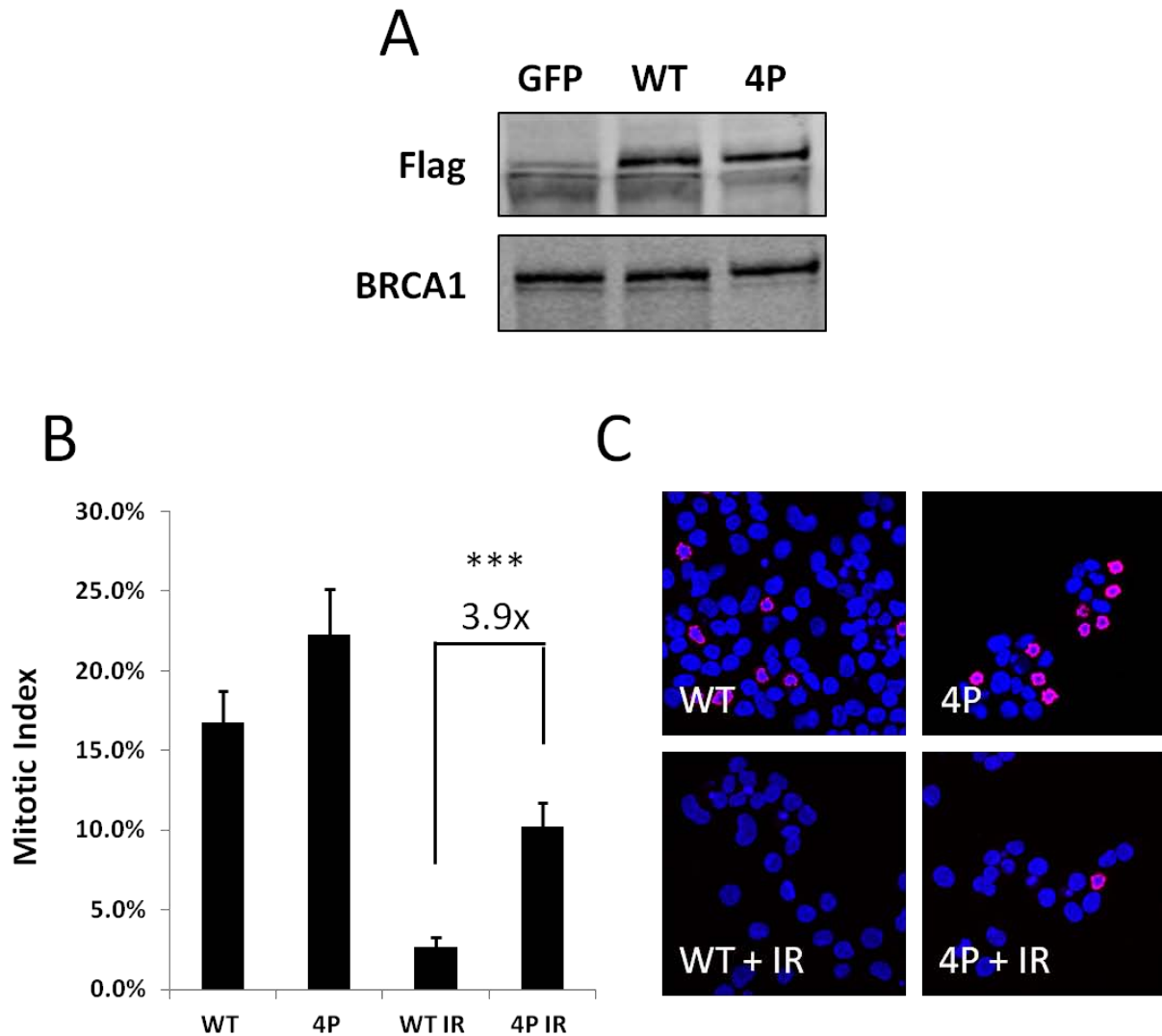

Figure 4.6 – Expression of a non-phosphorylatable BRCA1 mutant mimics the ATM-inhibited phenotype.

A) FLAG-BRCA1-WT and FLAG-BRCA1-4P expression in 293T cells. **B)** Transfection of hESCs with the BRCA1-WT and BRCA1-4P mutants mimic treatment with or without KU-60019. WT cells arrest strongly and do not enter mitosis; BRCA1-phospho-mutants demonstrate defective arrest and continue to cycle, significantly increasing the mitotic index.

C) Representative images of the quantitative data presented in **B**.

Blue = DAPI, Red = phospho-Histone H3.

Chapter Summary

While the experimental results presented in **Chapter 3** clearly demonstrate that ATM regulates the entry into and the progression through mitosis in hESCs, the mechanism by which it exerts this control is unknown. As discussed earlier, it is well established that activated ATM phosphorylates BRCA1, and there have been several papers published which demonstrate that BRCA1 plays a role in regulating the G2/M checkpoint. One pathway by which BRCA1 controls G2/M arrest is through its interaction with Aurora A. As Aurora A binds to and interacts with BRCA1 in the SQ cluster domain (the target of ATM's kinase activity), we turned our attention to BRCA1 and Aurora A in order to clarify how ATM activation affects this relationship and the transition into mitosis.

The data presented in **Chapter 4** indicates that ATM activation increases the phosphorylation of BRCA1, an event that is blocked by the addition of our ATM inhibitor, KU-60019. Interestingly, there appears to be a relatively high level of p-BRCA1, regardless of ATM activation or inhibition. This steady amount of phosphorylation on other downstream ATM-targeted proteins has not been seen in our hands, though we have investigated this in the past (Adams et al., 2010a, 2010b). As it is extremely

important for hESCs to maintain their genetic integrity, perhaps a constitutively phosphorylated/activated BRCA1 enhances its ability to detect and repair potentially harmful lesions in the DNA. Additionally, the high basal level of phosphorylation could account for the relative "leakiness" of the G2/M checkpoint that was shown in **Chapter 3**. If the phosphorylation of BRCA1 is important for checkpoint activation, but there is already a high level of p-BRCA1, then maybe the additional phosphorylation brought on by DNA damage is only partially successful in arresting the cell - a case of not being able to see the forest for the trees.

We were able to see BRCA1 and Aurora A interacting in hESCs, though this was only witnessed during the early-to-mid phases of mitosis. The most interesting result of these experiments was the relative failure of the endogenous BRCA1/Aurora A co-immunoprecipitation using the Santa Cruz C-20 BRCA1 antibody, arguably the most published, most successful BRCA1 antibody that is available. While BRCA1 could be routinely immunoprecipitated from hESC lysates, a constant, similar level of Aurora A co-immunoprecipitated with it, regardless of treatment. The fact that we were only able to tease out differences using the p-S1423-BRCA1 antibody suggests several possibilities. First, based on the results obtained in **Figure 4.1 A and B**, there seems to be a

small population of un-phosphorylated BRCA1 in hESCs. Perhaps this population always interacts with Aurora A, regardless of other events occurring in the cell. Second, many papers have been published describing BRCA1 interacting with a wide variety of proteins. The C-20 antibody recognizes the C-terminus of BRCA1 - the region in which many proteins have been shown to bind. It could be that, in hESCs, it is a simple case of too many partners interacting with BRCA1, preventing the antibody from recognizing its substrate. By using the p-S1423-BRCA1 antibody, we are trying to grasp on to a different "handle" of BRCA1 - one that is more successful. The fact that even after 5 Gy of IR there was still a small amount of Aurora A co-immunoprecipitating with p-BRCA1, and a small level of p-S308-BRCA1 detected, further corroborates the results presented in **Chapter 3** which suggest that hESCs have a relatively weak G2/M checkpoint.

As artificial modulation of ATM activity can prolong the stages of mitosis (described in **Chapter 3**) as well as the BRCA1/Aurora A interaction, perhaps the extra time measured is a result of abnormal microtubule nucleation instead of (or, in addition to) the cell "missing" DNA damage and letting the cycle continue. Without ATM becoming activated and blocking Aurora A from interacting with and phosphorylating BRCA1, BRCA1's ubiquitin

ligase activity remains unregulated and appropriate numbers of microtubules are not formed in a reasonable amount of time. By preventing ATM from phosphorylating BRCA1, the cell builds excessive amounts of the mitotic architecture (even in the face of DNA damage), and while it can successfully traverse mitosis, it does not do so without significant setbacks. Additionally, BRCA1 functions to prevent abnormal centrosome amplification. The recorded aneuploidy that results from continuous ATM inhibition (**Chapter 3**) might well be a result of the cell's failure to regulate BRCA1 and thus, more than two centrosomes per dividing cell are created, leading to multi-polar asters and the development of aneuploidy.

Finally, seeing similar results with the 4P BRCA1 mutant transfected hESCs (as compared to the ATM-inhibited treated cells) is promising, though this method is not without its drawbacks. Chief among the issues raised by assaying cells in this manner is the fact that the hESCs used continue to express their own endogenous and fully phosphorylatable BRCA1. However, similar experiments are currently being conducted in BRCA1-null ovarian cancer cells, and our results in these cells (deficient cell cycle checkpoints and DNA repair) have generally replicated what we have seen in hESCs (Dever, Beckta *et al*, in preparation).

The data presented in this chapter provides one plausible mechanism by which ATM activation causes G2/M arrest. It is likely that, similar to their differentiated cousins, many different proteins and pathways contribute to cell cycle arrest in pluripotent cells. These other pathways remain open for future study.

Chapter 5:

Conclusions

This work has demonstrated a clear role for the ATM kinase in human embryonic stem cells. ATM activates in response to both decatenation inhibition as well as irradiation-induced DNA damage, and this activation results in a G2/M arrest. Treatment of hESCs with a potent ATM-inhibitor, KU-60019, abrogates this arrest and allows cells to enter mitosis. Once past the G2/M checkpoint, ATM-inhibited cells experience a significantly prolonged mitosis, and concurrent inhibition of decatenation results in many instances of endoreduplication (where cells which have already copied their DNA enter mitosis, and, upon failing to separate appropriately, re-enter the cell cycle with a tetraploid amount of DNA). In line with this observation, continuous pharmacologic inhibition of ATM results in a significant increase in the average number of kinetochores per cell, indicating a stable gain of DNA content.

The experiments presented here indicate that one possible mechanism by which ATM enacts a G2/M arrest is through disrupting the BRCA1/Aurora A interaction. BRCA1's E3 ubiquitin ligase activity is important for regulating centrosome duplication (ensuring that only one centrosome copy is made per cell per cycle), as well as microtubule nucleation (the process by which microtubules are assembled from γ -tubulin building blocks). When activated, ATM phosphorylates the SQ cluster

domain of BRCA1, the region in which Aurora A binds. This phosphorylation prevents Aurora A from interacting with BRCA1 and, thus, prevents Aurora A from phosphorylating BRCA1 on S308, a modification which inhibits BRCA1's inhibition of microtubule formation. Without this phosphorylation, an adequate number of microtubules cannot be constructed, preventing the cell from entering mitosis. Our proposed model of G2/M arrest in hESCs can be visualized in **Figure 5.1**.

This mechanism lends itself well to some of the current theories of centrosomal participation in the DNA damage response and cell cycle checkpoint regulation. Like DNA, centrosomes are replicated once per cycle (in S phase), and this replication occurs in a semi-conservative manner. At the onset of mitosis, these two centrosomes separate, forming the iconic poles of the mitotic spindle (Löffler et al., 2006). One direct mechanism by which G2 arrest can be enacted is through the inhibition of this centrosomal separation. This response occurs in an ATM-dependent manner, and is mediated by a protein called Nek2 (Fletcher et al., 2004; Hinchcliffe et al., 2001), a kinase whose activity causes a loss of centriole cohesion and leads to the centrosomal separation (Fry et al., 1998; Helps et al., 2000; Mayor et al., 2000).

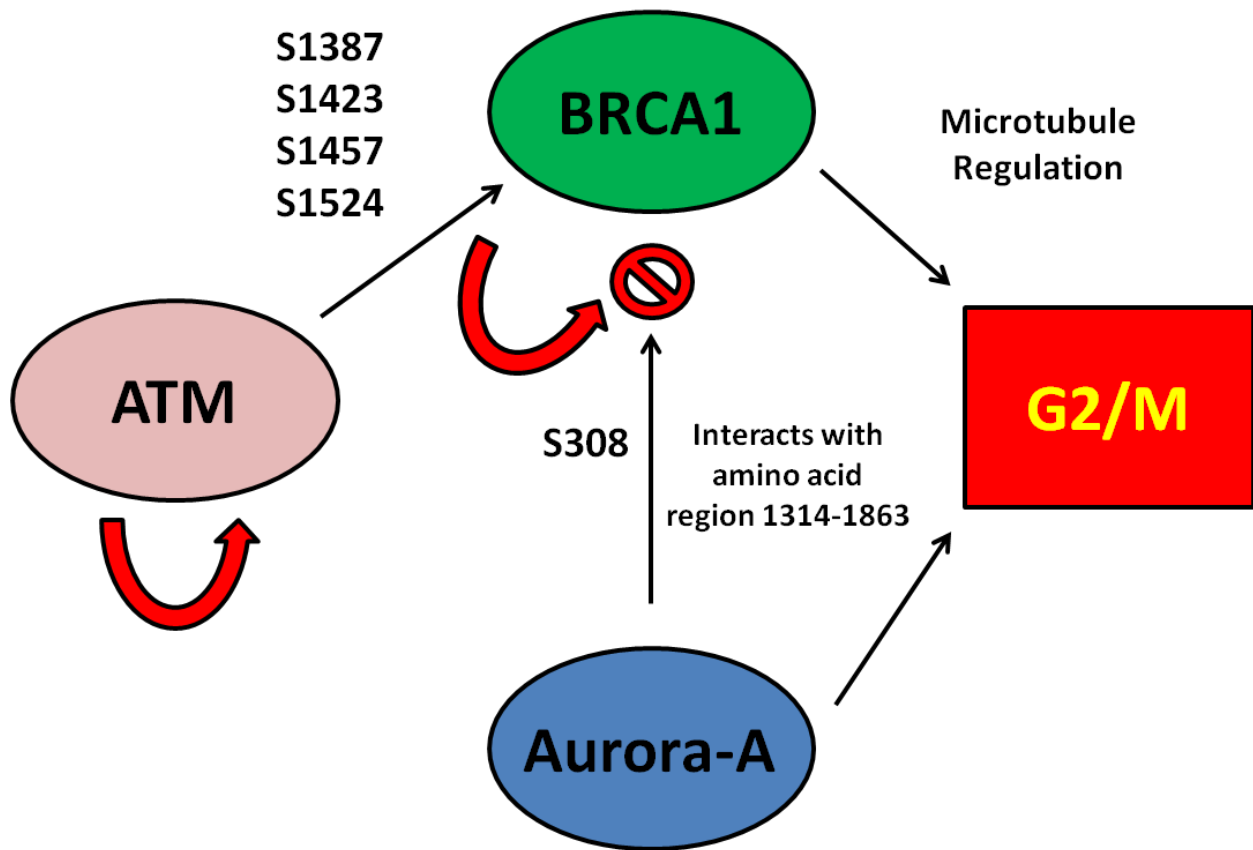

Figure 5.1 – ATM's hypothesized regulation of the BRCA1/Aurora A interaction and activation of G2/M arrest.

Going beyond direct regulation as a means of arrest, several laboratories have put forward the hypothesis that centrosomes act as "command centers" for cell cycle control (Doxsey, 2001; Doxsey et al., 2005; Krämer et al., 2004). Many proteins involved in both the DNA damage response as well as cell cycle regulation have been found to localize to and interact with each other around centrosomes, in times of both stress and normal growth. It seems as if centrosomes act as some sort of spatiotemporal organizing center for growth control and stress response - a place where proteins can go to communicate and "make decisions" about whether or not to proceed in cycling (see (Löffler et al., 2006), for perspective). Additionally, centrosomes can act as a place for the cell to sequester proteins to allow cycling to continue even in the presence of damage. One study performed in mESCs found the key cell cycle checkpoint protein Chk2 was localized to and retained at centrosomes, preventing it from activating a G1/S checkpoint (Hong and Stambrook, 2004). Interestingly, this effect could be overcome through ectopic expression of Chk2, indicating that it was indeed the centrosomal sequestration that was abrogating the G1/S checkpoint. Our model of ATM regulating BRCA1/Aurora A as a means of checkpoint control fits in well with these previously published studies.

One potential issue with the experiments presented within this dissertation is our reliance on pharmacologic inhibition of ATM, as opposed to siRNA-mediated knockdown. However, we feel that the use of a drug as opposed to knockdown provides several key benefits for our studies. Most importantly, it avoids the major toxicity we experience when attempting to transfect siRNA into hESCs. While it is possible to strike a balance between efficiency and toxicity, this balance usually leaves us with inadequate cell numbers to derive any meaningful conclusions. We have also found that the stress of transfection can occasionally cause differentiation, further discouraging the use of siRNA. Additionally, as we have shown KU-60019 to be extremely effective even at nanomolar concentrations (Golding et al., 2009), we can be reasonably sure that close to 100% of the cells are experiencing partial-to-complete inhibition of ATM, whereas it is highly unlikely that we could achieve such numbers with siRNA. Finally, the inhibitor can be used to quickly and transiently inhibit ATM. This avoids having to wait several days for the siRNA to exert its knockdown effect and allows us to conduct experiments in which the pharmacologic inhibition of ATM can be reversed (as was done in the kinetochore staining/aneuploidy assay in **Chapter 3**).

The use of a small molecule inhibitor of ATM versus protein knockdown in signaling studies does raise unique issues. In 2010, Chris Bakkenist's lab demonstrated that pharmacologic inhibition of ATM does not have the same phenotype as ATM protein knockdown or mutation (White et al., 2010). They speculate that this observation is the result of the kinase-inhibited ATM still being able to localize to and function structurally at sites of DNA DSBs (Choi et al., 2010). It is likely that this non-functional version of ATM serves as a physical barrier, preventing any "back-up" proteins from coming in and picking up some of the slack for the malfunctioning ATM kinase.

This could account for some of the differences seen in the literature between investigators examining ATM's function using either knockdown or small molecule inhibitors. For example, a paper recently published in Cell demonstrated that Aurora B phosphorylates ATM at S1403 during mitosis (in the absence of DNA damage) (Yang et al., 2011). Interestingly, these researchers found that ATM-null or -mutant cells had a significantly shortened progression through mitosis when compared to wild-type cells. This is in direct contrast to the findings presented in **Chapter 3**, where pharmacologic inhibition of ATM in hESCs significantly prolonged the time of mitosis.

Similar to "blocking" events at DSBs, kinase-inhibited ATM could still localize to and interact with key mitosis-promoting proteins, preventing the correct sequence of events and prolonging the mitotic sequence. Perhaps conducting studies using both protein knockdown and small molecule inhibitors could grant us greater insight into the true functions of ATM and other proteins.

Future Directions

As with any scientific investigation, the findings presented here only leave us with more unanswered questions. As such, there are still several ongoing experiments in this project that are not yet complete. The results of these studies will hopefully further clarify and reinforce that data which has already been presented.

First, more work needs to be done with the BRCA1 wild-type and 4-phospho-mutant constructs. If our hypothesis is correct, then the 4-phospho-mutant transfected cells should replicate most, if not all, of the ATM-inhibited cell cycle data. In parallel with this project, we have been using these BRCA1 constructs in a BRCA1-null ovarian cancer cell line to investigate similar endpoints (Dever & Beckta, in preparation). The data we have derived from these cancer cells have, so far, supported the data we have obtained in the hESCs. Most importantly, we need to demonstrate (using hESCs) that the 4-phospho-mutant BRCA1 can be immunoprecipitated, and that, when compared to wild-type BRCA1, more Aurora A is co-immunoprecipitated with it.

Second, we are in the process of creating an S308N-BRCA1 mutant construct to transfect into the stem cells. This version of BRCA1 should be unphosphorylatable by Aurora A, leaving BRCA1 free to ubiquitinate γ -tubulin as much as possible. These S308N cells should phenocopy cells that have undergone ATM activation and arrest in G2/M. Unfortunately, it is likely that mimicking chronic ATM activation will lead to heavily arrested growth (or massive death), and it might be difficult to assay these cells appropriately.

Finally, it would be interesting to repeat many of these studies (as well as our original studies examining the dynamic role of ATM and ATR in the DNA damage response) in human iPS cells. We have recently acquired well-characterized iPS cells from the Children's Hospital of California (Stover et al., 2013), which have already been adapted to our xenobiotic-free culture protocols. These cells are an ideal way to translate our methods into a new pluripotent system within which we can continue to rigorously test our hypotheses.

The work presented here continues to build upon the solid foundation of literature which has shown, time and time again, that our understanding of molecular signaling begins to break down when hESCs are involved. Pluripotent cells appear to be

governed by a different set of rules than their differentiated counterparts, and we still have much to learn. Clearly, a significant effort is needed to enhance our knowledge of the basic biology of these cells if we hope to employ them successfully in the clinic.

References:

- Abbas, T., and Dutta, A. (2009). p21 in cancer: intricate networks and multiple activities. *Nat. Rev. Cancer* 9, 400-414.
- Abbas, T., Keaton, M.A., and Dutta, A. (2013). Genomic instability in cancer. *Cold Spring Harb. Perspect. Biol.* 5, a012914.
- Abe, Y., Ohsugi, M., Haraguchi, K., Fujimoto, J., and Yamamoto, T. (2006). LATS2-Ajuba complex regulates gamma-tubulin recruitment to centrosomes and spindle organization during mitosis. *FEBS Lett.* 580, 782-788.
- Adams, B.R., Golding, S.E., Rao, R.R., and Valerie, K. (2010a). Dynamic dependence on ATR and ATM for double-strand break repair in human embryonic stem cells and neural descendants. *PLoS One* 5, e10001.
- Adams, B.R., Hawkins, A.J., Povirk, L.F., and Valerie, K. (2010b). ATM-independent, high-fidelity nonhomologous end joining predominates in human embryonic stem cells. *Aging (Albany NY)* 2, 582-596.
- Agarwal, M.L., Agarwal, A., Taylor, W.R., and Stark, G.R. (1995). p53 controls both the G2/M and the G1 cell cycle checkpoints and mediates reversible growth arrest in human fibroblasts. *Proc. Natl. Acad. Sci. U. S. A.* 92, 8493-8497.
- Amariglio, N., Hirshberg, A., Scheithauer, B.W., Cohen, Y., Loewenthal, R., Trakhtenbrot, L., Paz, N., Koren-Michowitz, M., Waldman, D., Leider-Trejo, L., et al. (2009). Donor-derived brain tumor following neural stem cell transplantation in an ataxia telangiectasia patient. *PLoS Med.* 6, e1000029.
- Amit, M., Carpenter, M.K., Inokuma, M.S., Chiu, C.P., Harris, C.P., Waknitz, M.A., Itskovitz-Eldor, J., and Thomson, J.A. (2000). Clonally derived human embryonic stem cell lines maintain pluripotency and proliferative potential for prolonged periods of culture. *Dev. Biol.* 227, 271-278.
- Annas, G.J., Caplan, A., and Elias, S. (1999). Stem cell politics, ethics and medical progress. *Nat. Med.* 5, 1339-1341.
- Atienza-Samols, S.B., and Sherman, M.I. (1978). Outgrowth promoting factor for the inner cell mass of the mouse blastocyst. *Dev. Biol.* 66, 220-231.

Baker, D.E.C., Harrison, N.J., Maltby, E., Smith, K., Moore, H.D., Shaw, P.J., Heath, P.R., Holden, H., and Andrews, P.W. (2007). Adaptation to culture of human embryonic stem cells and oncogenesis in vivo. *Nat. Biotechnol.* 25, 207-215.

Bakkenist, C.J., and Kastan, M.B. (2003). DNA damage activates ATM through intermolecular autophosphorylation and dimer dissociation. *Nature* 421, 499-506.

Barta, T., Dolezalova, D., Holubcova, Z., and Hampl, A. (2013). Cell cycle regulation in human embryonic stem cells: links to adaptation to cell culture. *Exp. Biol. Med.* Maywood NJ 238, 271-275.

Bárta, T., Vinarský, V., Holubcová, Z., Dolezalová, D., Verner, J., Pospíšilová, S., Dvorák, P., and Hampl, A. (2010). Human embryonic stem cells are capable of executing G1/S checkpoint activation. *Stem Cells Dayt. Ohio* 28, 1143-1152.

Bartek, J., and Lukas, J. (2007). DNA damage checkpoints: from initiation to recovery or adaptation. *Curr. Opin. Cell Biol.* 19, 238-245.

Bayliss, R., Sardon, T., Vernos, I., and Conti, E. (2003). Structural basis of Aurora-A activation by TPX2 at the mitotic spindle. *Mol. Cell* 12, 851-862.

Becker, K.A., Ghule, P.N., Therrien, J.A., Lian, J.B., Stein, J.L., van Wijnen, A.J., and Stein, G.S. (2006). Self-renewal of human embryonic stem cells is supported by a shortened G1 cell cycle phase. *J. Cell. Physiol.* 209, 883-893.

Becker, K.A., Ghule, P.N., Lian, J.B., Stein, J.L., van Wijnen, A.J., and Stein, G.S. (2010). Cyclin D2 and the CDK substrate p220(NPAT) are required for self-renewal of human embryonic stem cells. *J. Cell. Physiol.* 222, 456-464.

Beckta, J.M., Henderson, S.C., and Valerie, K. (2012). Two- and three-dimensional live cell imaging of DNA damage response proteins. *J. Vis. Exp. JoVE.*

Bennett, C.B., Snipe, J.R., and Resnick, M.A. (1997). A persistent double-strand break destabilizes human DNA in yeast and can lead to G2 arrest and lethality. *Cancer Res.* 57, 1970-1980.

Bensimon, A., Schmidt, A., Ziv, Y., Elkon, R., Wang, S.-Y., Chen, D.J., Aebersold, R., and Shiloh, Y. (2010). ATM-dependent

and -independent dynamics of the nuclear phosphoproteome after DNA damage. *Sci. Signal.* 3, rs3.

Berdnik, D., and Knoblich, J.A. (2002). *Drosophila* Aurora-A Is Required for Centrosome Maturation and Actin-Dependent Asymmetric Protein Localization during Mitosis. *Curr. Biol.* 12, 640-647.

Boheler, K.R. (2009). Stem cell pluripotency: a cellular trait that depends on transcription factors, chromatin state and a checkpoint deficient cell cycle. *J. Cell. Physiol.* 221, 10-17.

Bongso, A., Fong, C.Y., Ng, S.C., and Ratnam, S. (1994). Isolation and culture of inner cell mass cells from human blastocysts. *Hum. Reprod. Oxf. Engl.* 9, 2110-2117.

Boveri, T. (1902). On multipolar mitosis as a means of analysis of the cell nucleus. *Found. Exp. Embryol.* 1964, 74-97.

Bower, J.J., Karaca, G.F., Zhou, Y., Simpson, D.A., Cordeiro-Stone, M., and Kaufmann, W.K. (2010a). Topoisomerase IIalpha maintains genomic stability through decatenation G(2) checkpoint signaling. *Oncogene* 29, 4787-4799.

Bower, J.J., Zhou, Y., Zhou, T., Simpson, D.A., Arlander, S.J., Paules, R.S., Cordeiro-Stone, M., and Kaufmann, W.K. (2010b). Revised genetic requirements for the decatenation G2 checkpoint: the role of ATM. *Cell Cycle Georget. Tex* 9, 1617-1628.

Briggs, R., and King, T.J. (1952). Transplantation of Living Nuclei From Blastula Cells into Enucleated Frogs' Eggs. *Proc. Natl. Acad. Sci. U. S. A.* 38, 455-463.

Brodie, K.M., and Henderson, B.R. (2012). Characterization of BRCA1 protein targeting, dynamics, and function at the centrosome: a role for the nuclear export signal, CRM1, and Aurora A kinase. *J. Biol. Chem.* 287, 7701-7716.

Brooks, C.L., and Gu, W. (2010). New insights into p53 activation. *Cell Res.* 20, 614-621.

Brown, E.J., and Baltimore, D. (2000). ATR disruption leads to chromosomal fragmentation and early embryonic lethality. *Genes Dev.* 14, 397-402.

Burdon, T., Smith, A., and Savatier, P. (2002). Signalling, cell cycle and pluripotency in embryonic stem cells. *Trends Cell Biol.* 12, 432-438.

Caestecker, K.W., and Van de Walle, G.R. (2013). The role of BRCA1 in DNA double-strand repair: Past and present. *Exp. Cell Res.* 319, 575-587.

Campos, P.B., Sartore, R.C., Abdalla, S.N., and Rehen, S.K. (2009). Chromosomal Spread Preparation of Human Embryonic Stem Cells for Karyotyping. *J. Vis. Exp. JoVE.*

Cantor, S.B., Bell, D.W., Ganesan, S., Kass, E.M., Drapkin, R., Grossman, S., Wahrer, D.C., Sgroi, D.C., Lane, W.S., Haber, D.A., et al. (2001). BACH1, a novel helicase-like protein, interacts directly with BRCA1 and contributes to its DNA repair function. *Cell* 105, 149-160.

Chabalier-Taste, C., Racca, C., Dozier, C., and Larminat, F. (2008). BRCA1 is regulated by Chk2 in response to spindle damage. *Biochim. Biophys. Acta* 1783, 2223-2233.

Chai, Y.L., Cui, J., Shao, N., Shyam, E., Reddy, P., and Rao, V.N. (1999). The second BRCT domain of BRCA1 proteins interacts with p53 and stimulates transcription from the p21WAF1/CIP1 promoter. *Oncogene* 18, 263-268.

Chakrabarti, R., Jones, J.L., Oelschlager, D.K., Tapia, T., Tousson, A., and Grizzle, W.E. (2007). Phosphorylated LIM Kinases Colocalize with Gamma-Tubulin in Centrosomes During Early Stages of Mitosis. *Cell Cycle* 6, 2944-2952.

Chen, C.F., Li, S., Chen, Y., Chen, P.L., Sharp, Z.D., and Lee, W.H. (1996). The nuclear localization sequences of the BRCA1 protein interact with the importin-alpha subunit of the nuclear transport signal receptor. *J. Biol. Chem.* 271, 32863-32868.

Chen, S.-S., Chang, P.-C., Cheng, Y.-W., Tang, F.-M., and Lin, Y.-S. (2002). Suppression of the STK15 oncogenic activity requires a transactivation-independent p53 function. *EMBO J.* 21, 4491-4499.

Chen, T., Stephens, P.A., Middleton, F.K., and Curtin, N.J. (2012). Targeting the S and G2 checkpoint to treat cancer. *Drug Discov. Today* 17, 194-202.

Cherry, A.B.C., and Daley, G.Q. (2012). Reprogramming cellular identity for regenerative medicine. *Cell* 148, 1110-1122.

Choi, S., Gamper, A.M., White, J.S., and Bakkenist, C.J. (2010). Inhibition of ATM kinase activity does not phenocopy ATM protein

disruption: implications for the clinical utility of ATM kinase inhibitors. *Cell Cycle Georget. Tex* 9, 4052-4057.

Ciccica, A., and Elledge, S.J. (2010). The DNA damage response: making it safe to play with knives. *Mol. Cell* 40, 179-204.

Cole, R.J., and Paul, J. (2008). Properties of Cultured Preimplantation Mouse and Rabbit Embryos, and Cell Strains Derived from Them. In *Ciba Foundation Symposium - Preimplantation Stages of Pregnancy, G.E.W.W.O.B.E., , F. R. C. P. , F. I. Biol, and eve O. B.A, eds. (John Wiley & Sons, Ltd.), pp. 82-122.*

Conte, N., Delaval, B., Ginestier, C., Ferrand, A., Isnardon, D., Larroque, C., Prigent, C., Séraphin, B., Jacquemier, J., and Birnbaum, D. (2003). TACC1-chTOG-Aurora A protein complex in breast cancer. *Oncogene* 22, 8102-8116.

Cortez, D., Wang, Y., Qin, J., and Elledge, S.J. (1999). Requirement of ATM-dependent phosphorylation of brca1 in the DNA damage response to double-strand breaks. *Science* 286, 1162-1166.

Cosentino, C., Grieco, D., and Costanzo, V. (2011). ATM activates the pentose phosphate pathway promoting anti-oxidant defence and DNA repair. *EMBO J.* 30, 546-555.

Cowan, C.A., Atienza, J., Melton, D.A., and Eggan, K. (2005). Nuclear reprogramming of somatic cells after fusion with human embryonic stem cells. *Science* 309, 1369-1373.

Czornak, K., Chughtai, S., and Chrzanowska, K.H. (2008). Mystery of DNA repair: the role of the MRN complex and ATM kinase in DNA damage repair. *J. Appl. Genet.* 49, 383-396.

Damelin, M., and Bestor, T.H. (2007). The decatenation checkpoint. *Br. J. Cancer* 96, 201-205.

Damelin, M., Sun, Y.E., Sodja, V.B., and Bestor, T.H. (2005). Decatenation checkpoint deficiency in stem and progenitor cells. *Cancer Cell* 8, 479-484.

Deckbar, D., Birraux, J., Krempler, A., Tchouandong, L., Beucher, A., Walker, S., Stiff, T., Jeggo, P., and Löbrich, M. (2007). Chromosome breakage after G2 checkpoint release. *J. Cell Biol.* 176, 749-755.

Delacroix, S., Wagner, J.M., Kobayashi, M., Yamamoto, K., and Karnitz, L.M. (2007). The Rad9-Hus1-Rad1 (9-1-1) clamp activates checkpoint signaling via TopBP1. *Genes Dev.* 21, 1472-1477.

Deming, P.B., Flores, K.G., Downes, C.S., Paules, R.S., and Kaufmann, W.K. (2002). ATR enforces the topoisomerase II-dependent G2 checkpoint through inhibition of Plk1 kinase. *J. Biol. Chem.* 277, 36832-36838.

Deng, C.X. (2001). Tumorigenesis as a consequence of genetic instability in Brcal mutant mice. *Mutat. Res.* 477, 183-189.

Dever, S.M., Golding, S.E., Rosenberg, E., Adams, B.R., Idowu, M.O., Quillin, J.M., Valerie, N., Xu, B., Povirk, L.F., and Valerie, K. (2011). Mutations in the BRCT binding site of BRCA1 result in hyper-recombination. *Aging* 3, 515-532.

Diehl, J.A., Cheng, M., Roussel, M.F., and Sherr, C.J. (1998). Glycogen synthase kinase-3beta regulates cyclin D1 proteolysis and subcellular localization. *Genes Dev.* 12, 3499-3511.

Dolezalova, D., Mraz, M., Barta, T., Plevova, K., Vinarsky, V., Holubcova, Z., Jaros, J., Dvorak, P., Pospisilova, S., and Hampl, A. (2012). MicroRNAs regulate p21(Waf1/Cip1) protein expression and the DNA damage response in human embryonic stem cells. *Stem Cells Dayt. Ohio* 30, 1362-1372.

Doré, A.S., Kilkenny, M.L., Rzechorzek, N.J., and Pearl, L.H. (2009). Crystal structure of the rad9-rad1-hus1 DNA damage checkpoint complex--implications for clamp loading and regulation. *Mol. Cell* 34, 735-745.

Downes, C.S., Clarke, D.J., Mullinger, A.M., Giménez-Abián, J.F., Creighton, A.M., and Johnson, R.T. (1994). A topoisomerase II-dependent G2 cycle checkpoint in mammalian cells/. *Nature* 372, 467-470.

Doxsey, S.J. (2001). Centrosomes as command centres for cellular control. *Nat. Cell Biol.* 3, E105-108.

Doxsey, S., Zimmerman, W., and Mikule, K. (2005). Centrosome control of the cell cycle. *Trends Cell Biol.* 15, 303-311.

Draper, J.S., Smith, K., Gokhale, P., Moore, H.D., Maltby, E., Johnson, J., Meisner, L., Zwaka, T.P., Thomson, J.A., and Andrews, P.W. (2004). Recurrent gain of chromosomes 17q and 12 in cultured human embryonic stem cells. *Nat. Biotechnol.* 22, 53-54.

Duch, A., de Nadal, E., and Posas, F. (2012). The p38 and Hog1 SAPKs control cell cycle progression in response to environmental stresses. *FEBS Lett.* 586, 2925-2931.

Dutertre, S., Cazales, M., Quaranta, M., Froment, C., Trabut, V., Dozier, C., Mirey, G., Bouché, J.-P., Theis-Febvre, N., Schmitt, E., et al. (2004). Phosphorylation of CDC25B by Aurora-A at the centrosome contributes to the G2-M transition. *J. Cell Sci.* 117, 2523-2531.

Evans, M.J., and Kaufman, M.H. (1981). Establishment in culture of pluripotential cells from mouse embryos. *Nature* 292, 154-156.

Evans, T., Rosenthal, E.T., Youngblom, J., Distel, D., and Hunt, T. (1983). Cyclin: a protein specified by maternal mRNA in sea urchin eggs that is destroyed at each cleavage division. *Cell* 33, 389-396.

Eyers, P.A., Erikson, E., Chen, L.G., and Maller, J.L. (2003). A novel mechanism for activation of the protein kinase Aurora A. *Curr. Biol.* CB 13, 691-697.

Fabbro, M., Rodriguez, J.A., Baer, R., and Henderson, B.R. (2002). BARD1 induces BRCA1 intranuclear foci formation by increasing RING-dependent BRCA1 nuclear import and inhibiting BRCA1 nuclear export. *J. Biol. Chem.* 277, 21315-21324.

Ferreira, L.M.R., and Mostajo-Radji, M.A. (2013). How induced pluripotent stem cells are redefining personalized medicine. *Gene* 520, 1-6.

Filion, T.M., Qiao, M., Ghule, P.N., Mandeville, M., van Wijnen, A.J., Stein, J.L., Lian, J.B., Altieri, D.C., and Stein, G.S. (2009). Survival responses of human embryonic stem cells to DNA damage. *J. Cell. Physiol.* 220, 586-592.

Filipczyk, A.A., Laslett, A.L., Mummery, C., and Pera, M.F. (2007). Differentiation is coupled to changes in the cell cycle regulatory apparatus of human embryonic stem cells. *Stem Cell Res.* 1, 45-60.

Fletcher, L., Cerniglia, G.J., Nigg, E.A., Yend, T.J., and Muschel, R.J. (2004). Inhibition of centrosome separation after DNA damage: a role for Nek2. *Radiat. Res.* 162, 128-135.

Fry, A.M., Mayor, T., Meraldi, P., Stierhof, Y.D., Tanaka, K., and Nigg, E.A. (1998). C-Nap1, a novel centrosomal coiled-coil

protein and candidate substrate of the cell cycle-regulated protein kinase Nek2. *J. Cell Biol.* 141, 1563-1574.

Fukasawa, K., Choi, T., Kuriyama, R., Rulong, S., and Vande Woude, G.F. (1996). Abnormal centrosome amplification in the absence of p53. *Science* 271, 1744-1747.

Garrett, M.D., and Collins, I. (2011). Anticancer therapy with checkpoint inhibitors: what, where and when? *Trends Pharmacol. Sci.* 32, 308-316.

Gatei, M., Scott, S.P., Filippovitch, I., Soronika, N., Lavin, M.F., Weber, B., and Khanna, K.K. (2000). Role for ATM in DNA damage-induced phosphorylation of BRCA1. *Cancer Res.* 60, 3299-3304.

Gatei, M., Zhou, B.B., Hobson, K., Scott, S., Young, D., and Khanna, K.K. (2001). Ataxia telangiectasia mutated (ATM) kinase and ATM and Rad3 related kinase mediate phosphorylation of Brca1 at distinct and overlapping sites. In vivo assessment using phospho-specific antibodies. *J. Biol. Chem.* 276, 17276-17280.

Ge, X.Q., and Blow, J.J. (2010). Chk1 inhibits replication factory activation but allows dormant origin firing in existing factories. *J. Cell Biol.* 191, 1285-1297.

Ge, X.Q., Jackson, D.A., and Blow, J.J. (2007). Dormant origins licensed by excess Mcm2-7 are required for human cells to survive replicative stress. *Genes Dev.* 21, 3331-3341.

Giet, R., Uzbekov, R., Cubizolles, F., Le Guellec, K., and Prigent, C. (1999). The *Xenopus laevis* aurora-related protein kinase pEg2 associates with and phosphorylates the kinesin-related protein XlEg5. *J. Biol. Chem.* 274, 15005-15013.

Glover, D.M., Leibowitz, M.H., McLean, D.A., and Parry, H. (1995). Mutations in aurora prevent centrosome separation leading to the formation of monopolar spindles. *Cell* 81, 95-105.

Golding, S.E., Rosenberg, E., Valerie, N., Hussaini, I., Frigerio, M., Cockcroft, X.F., Chong, W.Y., Hummersone, M., Rigoreau, L., Menear, K.A., et al. (2009). Improved ATM kinase inhibitor KU-60019 radiosensitizes glioma cells, compromises insulin, AKT and ERK prosurvival signaling, and inhibits migration and invasion. *Mol. Cancer Ther.* 8, 2894-2902.

- Gottweis, H. (2010). The endless hESC controversy in the United States: history, context, and prospects. *Cell Stem Cell* 7, 555-558.
- Grallert, B., and Boye, E. (2008). The multiple facets of the intra-S checkpoint. *Cell Cycle Georget. Tex* 7, 2315-2320.
- Greco, S.J., Liu, K., and Rameshwar, P. (2007). Functional similarities among genes regulated by OCT4 in human mesenchymal and embryonic stem cells. *Stem Cells Dayt. Ohio* 25, 3143-3154.
- Greer Card, D.A., Sierant, M.L., and Davey, S. (2010). Rad9A is required for G2 decatenation checkpoint and to prevent endoreduplication in response to topoisomerase II inhibition. *J. Biol. Chem.* 285, 15653-15661.
- Guo, Z., Kozlov, S., Lavin, M.F., Person, M.D., and Paull, T.T. (2010). ATM activation by oxidative stress. *Science* 330, 517-521.
- Hadian, K., and Krappmann, D. (2011). Signals from the nucleus: activation of NF-kappaB by cytosolic ATM in the DNA damage response. *Sci. Signal.* 4, pe2.
- Hall, E.J., and Giaccia, A.J. (2012). *Radiobiology for the Radiologist* (Wolters Kluwer Health/Lippincott Williams & Wilkins).
- Hanahan, D., and Weinberg, R.A. (2000). The hallmarks of cancer. *Cell* 100, 57-70.
- Hanna, J., Wernig, M., Markoulaki, S., Sun, C.-W., Meissner, A., Cassady, J.P., Beard, C., Brambrink, T., Wu, L.-C., Townes, T.M., et al. (2007). Treatment of sickle cell anemia mouse model with iPS cells generated from autologous skin. *Science* 318, 1920-1923.
- Hannak, E., Kirkham, M., Hyman, A.A., and Oegema, K. (2001). Aurora-A kinase is required for centrosome maturation in *Caenorhabditis elegans*. *J. Cell Biol.* 155, 1109-1116.
- Harvey, A.J. (2007). The role of oxygen in ruminant preimplantation embryo development and metabolism. *Anim. Reprod. Sci.* 98, 113-128.
- Helps, N.R., Luo, X., Barker, H.M., and Cohen, P.T. (2000). NIMA-related kinase 2 (Nek2), a cell-cycle-regulated protein

kinase localized to centrosomes, is complexed to protein phosphatase 1. *Biochem. J.* 349, 509-518.

Van den Heuvel, S., and Dyson, N.J. (2008). Conserved functions of the pRB and E2F families. *Nat. Rev. Mol. Cell Biol.* 9, 713-724.

Hill, R., and Lee, P.W.K. (2010). The DNA-dependent protein kinase (DNA-PK): More than just a case of making ends meet? *Cell Cycle Georget. Tex* 9, 3460-3469.

Hinchcliffe, E.H., Miller, F.J., Cham, M., Khodjakov, A., and Sluder, G. (2001). Requirement of a centrosomal activity for cell cycle progression through G1 into S phase. *Science* 291, 1547-1550.

Hirota, T., Kunitoku, N., Sasayama, T., Marumoto, T., Zhang, D., Nitta, M., Hatakeyama, K., and Saya, H. (2003). Aurora-A and an interacting activator, the LIM protein Ajuba, are required for mitotic commitment in human cells. *Cell* 114, 585-598.

Hong, Y., and Stambrook, P.J. (2004). Restoration of an absent G1 arrest and protection from apoptosis in embryonic stem cells after ionizing radiation. *Proc. Natl. Acad. Sci. U. S. A.* 101, 14443-14448.

Hutterer, A., Berdnik, D., Wirtz-Peitz, F., Zigman, M., Schleiffer, A., and Knoblich, J.A. (2006). Mitotic activation of the kinase Aurora-A requires its binding partner Bora. *Dev. Cell* 11, 147-157.

Hyka-Nouspikel, N., Desmarais, J., Gokhale, P.J., Jones, M., Meuth, M., Andrews, P.W., and Nouspikel, T. (2012). Deficient DNA damage response and cell cycle checkpoints lead to accumulation of point mutations in human embryonic stem cells. *Stem Cells Dayt. Ohio* 30, 1901-1910.

Jackman, M., Lindon, C., Nigg, E.A., and Pines, J. (2003). Active cyclin B1-Cdk1 first appears on centrosomes in prophase. *Nat. Cell Biol.* 5, 143-148.

Jazayeri, A., Balestrini, A., Garner, E., Haber, J.E., and Costanzo, V. (2008). Mre11-Rad50-Nbs1-dependent processing of DNA breaks generates oligonucleotides that stimulate ATM activity. *EMBO J.* 27, 1953-1962.

Jiang, Y., Jahagirdar, B.N., Reinhardt, R.L., Schwartz, R.E., Keene, C.D., Ortiz-Gonzalez, X.R., Reyes, M., Lenvik, T., Lund,

T., Blackstad, M., et al. (2002). Pluripotency of mesenchymal stem cells derived from adult marrow. *Nature* 418, 41-49.

Jirmanova, L., Bulavin, D.V., and Fornace, A.J., Jr (2005). Inhibition of the ATR/Chk1 pathway induces a p38-dependent S-phase delay in mouse embryonic stem cells. *Cell Cycle Georget. Tex* 4, 1428-1434.

Kanatsu-Shinohara, M., Inoue, K., Lee, J., Yoshimoto, M., Ogonuki, N., Miki, H., Baba, S., Kato, T., Kazuki, Y., Toyokuni, S., et al. (2004). Generation of pluripotent stem cells from neonatal mouse testis. *Cell* 119, 1001-1012.

Kanda, T., Sullivan, K.F., and Wahl, G.M. (1998). Histone-GFP fusion protein enables sensitive analysis of chromosome dynamics in living mammalian cells. *Curr. Biol. CB* 8, 377-385.

Kandel, E.S., Skeen, J., Majewski, N., Di Cristofano, A., Pandolfi, P.P., Feliciano, C.S., Gartel, A., and Hay, N. (2002). Activation of Akt/protein kinase B overcomes a G(2)/m cell cycle checkpoint induced by DNA damage. *Mol. Cell. Biol.* 22, 7831-7841.

Katayama, H., Brinkley, W.R., and Sen, S. (2003). The Aurora kinases: role in cell transformation and tumorigenesis. *Cancer Metastasis Rev.* 22, 451-464.

Katayama, H., Sasai, K., Kawai, H., Yuan, Z.-M., Bondaruk, J., Suzuki, F., Fujii, S., Arlinghaus, R.B., Czerniak, B.A., and Sen, S. (2004). Phosphorylation by aurora kinase A induces Mdm2-mediated destabilization and inhibition of p53. *Nat. Genet.* 36, 55-62.

Kim, D., Kim, C.-H., Moon, J.-I., Chung, Y.-G., Chang, M.-Y., Han, B.-S., Ko, S., Yang, E., Cha, K.Y., Lanza, R., et al. (2009). Generation of human induced pluripotent stem cells by direct delivery of reprogramming proteins. *Cell Stem Cell* 4, 472-476.

Koledova, Z., Krämer, A., Kafkova, L.R., and Divoky, V. (2010). Cell-cycle regulation in embryonic stem cells: centrosomal decisions on self-renewal. *Stem Cells Dev.* 19, 1663-1678.

Krämer, A., Lukas, J., and Bartek, J. (2004). Checking out the centrosome. *Cell Cycle Georget. Tex* 3, 1390-1393.

Kufer, T.A., Silljé, H.H.W., Körner, R., Gruss, O.J., Meraldi, P., and Nigg, E.A. (2002). Human TPX2 is required for targeting Aurora-A kinase to the spindle. *J. Cell Biol.* 158, 617-623.

Kumaraswamy, E., and Shiekhattar, R. (2007). Activation of BRCA1/BRCA2-associated helicase BACH1 is required for timely progression through S phase. *Mol. Cell. Biol.* 27, 6733-6741.

Labib, K., and De Piccoli, G. (2011). Surviving chromosome replication: the many roles of the S-phase checkpoint pathway. *Philos. Trans. R. Soc. Lond. B. Biol. Sci.* 366, 3554-3561.

Lavin, M.F. (2008). Ataxia-telangiectasia: from a rare disorder to a paradigm for cell signalling and cancer. *Nat. Rev. Mol. Cell Biol.* 9, 759-769.

Lee, J.-H., and Paull, T.T. (2005). ATM activation by DNA double-strand breaks through the Mre11-Rad50-Nbs1 complex. *Science* 308, 551-554.

Lee, D.-F., Su, J., Ang, Y.-S., Carvajal-Vergara, X., Mulero-Navarro, S., Pereira, C.F., Gingold, J., Wang, H.-L., Zhao, R., Sevilla, A., et al. (2012). Regulation of embryonic and induced pluripotency by aurora kinase-p53 signaling. *Cell Stem Cell* 11, 179-194.

Lee, J., Go, Y., Kang, I., Han, Y.-M., and Kim, J. (2010). Oct-4 controls cell-cycle progression of embryonic stem cells. *Biochem. J.* 426, 171-181.

Lemaire, M., Froment, C., Boutros, R., Mondesert, O., Nebreda, A.R., Monsarrat, B., and Ducommun, B. (2006). CDC25B phosphorylation by p38 and MK-2. *Cell Cycle Georget. Tex* 5, 1649-1653.

Li, S., Chen, P.L., Subramanian, T., Chinnadurai, G., Tomlinson, G., Osborne, C.K., Sharp, Z.D., and Lee, W.H. (1999). Binding of CtIP to the BRCT repeats of BRCA1 involved in the transcription regulation of p21 is disrupted upon DNA damage. *J. Biol. Chem.* 274, 11334-11338.

Lindqvist, A., Källström, H., Lundgren, A., Barsoum, E., and Rosenthal, C.K. (2005). Cdc25B cooperates with Cdc25A to induce mitosis but has a unique role in activating cyclin B1-Cdk1 at the centrosome. *J. Cell Biol.* 171, 35-45.

Litman, R., Peng, M., Jin, Z., Zhang, F., Zhang, J., Powell, S., Andreassen, P.R., and Cantor, S.B. (2005). BACH1 is critical for

homologous recombination and appears to be the Fanconi anemia gene product FANCD1. *Cancer Cell* 8, 255-265.

Liu, Q., and Ruderman, J.V. (2006). Aurora A, mitotic entry, and spindle bipolarity. *Proc. Natl. Acad. Sci. U. S. A.* 103, 5811-5816.

Liu, Q., Kaneko, S., Yang, L., Feldman, R.I., Nicosia, S.V., Chen, J., and Cheng, J.Q. (2004). Aurora-A abrogation of p53 DNA binding and transactivation activity by phosphorylation of serine 215. *J. Biol. Chem.* 279, 52175-52182.

Löbrich, M., and Jeggo, P.A. (2007). The impact of a negligent G2/M checkpoint on genomic instability and cancer induction. *Nat. Rev. Cancer* 7, 861-869.

Löffler, H., Lukas, J., Bartek, J., and Krämer, A. (2006). Structure meets function--centrosomes, genome maintenance and the DNA damage response. *Exp. Cell Res.* 312, 2633-2640.

Longo, L., Bygrave, A., Grosveld, F.G., and Pandolfi, P.P. (1997). The chromosome make-up of mouse embryonic stem cells is predictive of somatic and germ cell chimaerism. *Transgenic Res.* 6, 321-328.

Lundblad, V. (2000). DNA ends: maintenance of chromosome termini versus repair of double strand breaks. *Mutat. Res.* 451, 227-240.

Luo, K., Yuan, J., Chen, J., and Lou, Z. (2009). Topoisomerase IIa controls the decatenation checkpoint. *Nat. Cell Biol.* 11, 204-210.

Mackenzie, I.C. (2006). Stem cell properties and epithelial malignancies. *Eur. J. Cancer Oxf. Engl.* 1990 42, 1204-1212.

Maimets, T., Neganova, I., Armstrong, L., and Lako, M. (2008). Activation of p53 by nutlin leads to rapid differentiation of human embryonic stem cells. *Oncogene* 27, 5277-5287.

Maitra, A., Arking, D.E., Shivapurkar, N., Ikeda, M., Stastny, V., Kassauei, K., Sui, G., Cutler, D.J., Liu, Y., Brimble, S.N., et al. (2005). Genomic alterations in cultured human embryonic stem cells. *Nat. Genet.* 37, 1099-1103.

Mallery, D.L., Vandenberg, C.J., and Hiom, K. (2002). Activation of the E3 ligase function of the BRCA1/BARD1 complex by polyubiquitin chains. *EMBO J.* 21, 6755-6762.

Manke, I.A., Lowery, D.M., Nguyen, A., and Yaffe, M.B. (2003). BRCT repeats as phosphopeptide-binding modules involved in protein targeting. *Science* 302, 636-639.

Manke, I.A., Nguyen, A., Lim, D., Stewart, M.Q., Elia, A.E.H., and Yaffe, M.B. (2005). MAPKAP kinase-2 is a cell cycle checkpoint kinase that regulates the G2/M transition and S phase progression in response to UV irradiation. *Mol. Cell* 17, 37-48.

Matsuoka, S., Ballif, B.A., Smogorzewska, A., McDonald, E.R., 3rd, Hurov, K.E., Luo, J., Bakalarski, C.E., Zhao, Z., Solimini, N., Lerenthal, Y., et al. (2007a). ATM and ATR substrate analysis reveals extensive protein networks responsive to DNA damage. *Science* 316, 1160-1166.

Matsuoka, S., Ballif, B.A., Smogorzewska, A., McDonald, E.R., 3rd, Hurov, K.E., Luo, J., Bakalarski, C.E., Zhao, Z., Solimini, N., Lerenthal, Y., et al. (2007b). ATM and ATR substrate analysis reveals extensive protein networks responsive to DNA damage. *Science* 316, 1160-1166.

Matsusaka, T., and Pines, J. (2004). Chfr acts with the p38 stress kinases to block entry to mitosis in mammalian cells. *J. Cell Biol.* 166, 507-516.

Mayor, T., Stierhof, Y.D., Tanaka, K., Fry, A.M., and Nigg, E.A. (2000). The centrosomal protein C-Nap1 is required for cell cycle-regulated centrosome cohesion. *J. Cell Biol.* 151, 837-846.

Mayshar, Y., Ben-David, U., Lavon, N., Biancotti, J.-C., Yakir, B., Clark, A.T., Plath, K., Lowry, W.E., and Benvenisty, N. (2010). Identification and classification of chromosomal aberrations in human induced pluripotent stem cells. *Cell Stem Cell* 7, 521-531.

McCool, K.W., and Miyamoto, S. (2012). DNA damage-dependent NF- κ B activation: NEMO turns nuclear signaling inside out. *Immunol. Rev.* 246, 311-326.

Meraldi, P., Honda, R., and Nigg, E.A. (2002). Aurora-A overexpression reveals tetraploidization as a major route to centrosome amplification in p53^{-/-} cells. *EMBO J.* 21, 483-492.

Meshorer, E., Yellajoshula, D., George, E., Scambler, P.J., Brown, D.T., and Misteli, T. (2006). Hyperdynamic plasticity of chromatin proteins in pluripotent embryonic stem cells. *Dev. Cell* 10, 105-116.

- Mikhailov, A., Shinohara, M., and Rieder, C.L. (2004). Topoisomerase II and histone deacetylase inhibitors delay the G2/M transition by triggering the p38 MAPK checkpoint pathway. *J. Cell Biol.* 166, 517-526.
- Mikhailov, A., Shinohara, M., and Rieder, C.L. (2005). The p38-mediated stress-activated checkpoint. A rapid response system for delaying progression through antephasis and entry into mitosis. *Cell Cycle Georget. Tex* 4, 57-62.
- Mikhailov, A., Patel, D., McCance, D.J., and Rieder, C.L. (2007). The G2 p38-mediated stress-activated checkpoint pathway becomes attenuated in transformed cells. *Curr. Biol. CB* 17, 2162-2168.
- Miki, Y., Swensen, J., Shattuck-Eidens, D., Futreal, P.A., Harshman, K., Tavtigian, S., Liu, Q., Cochran, C., Bennett, L.M., and Ding, W. (1994). A strong candidate for the breast and ovarian cancer susceptibility gene BRCA1. *Science* 266, 66-71.
- Mitalipova, M.M., Rao, R.R., Hoyer, D.M., Johnson, J.A., Meisner, L.F., Jones, K.L., Dalton, S., and Stice, S.L. (2005). Preserving the genetic integrity of human embryonic stem cells. *Nat. Biotechnol.* 23, 19-20.
- Moll, U.M., and Petrenko, O. (2003). The MDM2-p53 Interaction. *Mol. Cancer Res.* 1, 1001-1008.
- Momcilović, O., Choi, S., Varum, S., Bakkenist, C., Schatten, G., and Navara, C. (2009). Ionizing radiation induces ataxia telangiectasia mutated-dependent checkpoint signaling and G(2) but not G(1) cell cycle arrest in pluripotent human embryonic stem cells. *Stem Cells Dayt. Ohio* 27, 1822-1835.
- Morgan, D.O. (2007). *The cell cycle: principles of control* (London: Sunderland, MA: New Science Press; Sinauer Associates).
- Mori, D., Yano, Y., Toyo-oka, K., Yoshida, N., Yamada, M., Muramatsu, M., Zhang, D., Saya, H., Toyoshima, Y.Y., Kinoshita, K., et al. (2007). NDEL1 phosphorylation by Aurora-A kinase is essential for centrosomal maturation, separation, and TACC3 recruitment. *Mol. Cell. Biol.* 27, 352-367.
- Moritz, M., Braunfeld, M.B., Sedat, J.W., Alberts, B., and Agard, D.A. (1995). Microtubule nucleation by gamma-tubulin-containing rings in the centrosome. *Nature* 378, 638-640.

- Nagaria, P., Robert, C., and Rassool, F.V. (2013). DNA double-strand break response in stem cells: Mechanisms to maintain genomic integrity. *Biochim. Biophys. Acta BBA - Gen. Subj.* 1830, 2345-2353.
- Nakagawa, T., Hayashita, Y., Maeno, K., Masuda, A., Sugito, N., Osada, H., Yanagisawa, K., Ebi, H., Shimokata, K., and Takahashi, T. (2004). Identification of decatenation G2 checkpoint impairment independently of DNA damage G2 checkpoint in human lung cancer cell lines. *Cancer Res.* 64, 4826-4832.
- Neal, J.A., and Meek, K. (2011). Choosing the right path: does DNA-PK help make the decision? *Mutat. Res.* 711, 73-86.
- Neganova, I., Zhang, X., Atkinson, S., and Lako, M. (2008). Expression and functional analysis of G1 to S regulatory components reveals an important role for CDK2 in cell cycle regulation in human embryonic stem cells. *Oncogene* 28, 20-30.
- Nikonova, A.S., Astsaturov, I., Serebriiskii, I.G., Dunbrack, R.L., Jr, and Golemis, E.A. (2013). Aurora A kinase (AURKA) in normal and pathological cell division. *Cell. Mol. Life Sci. CMLS* 70, 661-687.
- Nishikawa, H., Ooka, S., Sato, K., Arima, K., Okamoto, J., Klevit, R.E., Fukuda, M., and Ohta, T. (2004). Mass spectrometric and mutational analyses reveal Lys-6-linked polyubiquitin chains catalyzed by BRCA1-BARD1 ubiquitin ligase. *J. Biol. Chem.* 279, 3916-3924.
- Nospikel, T. (2013). Genetic instability in human embryonic stem cells: prospects and caveats. *Future Oncol. Lond. Engl.* 9, 867-877.
- Nurse, P., and Bissett, Y. (1981). Gene required in G1 for commitment to cell cycle and in G2 for control of mitosis in fission yeast. *Nature* 292, 558-560.
- Nurse, P., and Thuriaux, P. (1980). Regulatory genes controlling mitosis in the fission yeast *Schizosaccharomyces pombe*. *Genetics* 96, 627-637.
- O'Driscoll, M., Ruiz-Perez, V.L., Woods, C.G., Jeggo, P.A., and Goodship, J.A. (2003). A splicing mutation affecting expression of ataxia-telangiectasia and Rad3-related protein (ATR) results in Seckel syndrome. *Nat. Genet.* 33, 497-501.

Ouchi, M., Fujiuchi, N., Sasai, K., Katayama, H., Minamishima, Y.A., Ongusaha, P.P., Deng, C., Sen, S., Lee, S.W., and Ouchi, T. (2004). BRCA1 phosphorylation by Aurora-A in the regulation of G2 to M transition. *J. Biol. Chem.* 279, 19643-19648.

Ouchi, T., Monteiro, A.N., August, A., Aaronson, S.A., and Hanafusa, H. (1998). BRCA1 regulates p53-dependent gene expression. *Proc. Natl. Acad. Sci. U. S. A.* 95, 2302-2306.

Pao, G.M., Janknecht, R., Ruffner, H., Hunter, T., and Verma, I.M. (2000). CBP/p300 interact with and function as transcriptional coactivators of BRCA1. *Proc. Natl. Acad. Sci. U. S. A.* 97, 1020-1025.

Park, I.-H., Arora, N., Huo, H., Maherali, N., Ahfeldt, T., Shimamura, A., Lensch, M.W., Cowan, C., Hochedlinger, K., and Daley, G.Q. (2008). Disease-specific induced pluripotent stem cells. *Cell* 134, 877-886.

Perlman, S.L., Boder Deceased, E., Sedgewick, R.P., and Gatti, R.A. (2012). Ataxia-telangiectasia. *Handb. Clin. Neurol.* 103, 307-332.

Rashi-Elkeles, S., Elkon, R., Weizman, N., Linhart, C., Amariglio, N., Sternberg, G., Rechavi, G., Barzilai, A., Shamir, R., and Shiloh, Y. (2006). Parallel induction of ATM-dependent pro- and antiapoptotic signals in response to ionizing radiation in murine lymphoid tissue. *Oncogene* 25, 1584-1592.

Reinhardt, H.C., Aslanian, A.S., Lees, J.A., and Yaffe, M.B. (2007). p53-deficient cells rely on ATM- and ATR-mediated checkpoint signaling through the p38MAPK/MK2 pathway for survival after DNA damage. *Cancer Cell* 11, 175-189.

Reubinoff, B.E., Pera, M.F., Fong, C.Y., Trounson, A., and Bongso, A. (2000). Embryonic stem cell lines from human blastocysts: somatic differentiation in vitro. *Nat. Biotechnol.* 18, 399-404.

Rieder, C.L. (2011). Mitosis in vertebrates: the G2/M and M/A transitions and their associated checkpoints. *Chromosome Res. Int. J. Mol. Supramol. Evol. Asp. Chromosome Biol.* 19, 291-306.

Ritchey, L., Ottman, R., Roumanos, M., and Chakrabarti, R. (2012). A functional cooperativity between Aurora A kinase and LIM kinase1: implication in the mitotic process. *Cell Cycle Georget. Tex* 11, 296-309.

- Roca, J., Ishida, R., Berger, J.M., Andoh, T., and Wang, J.C. (1994). Antitumor bisdioxopiperazines inhibit yeast DNA topoisomerase II by trapping the enzyme in the form of a closed protein clamp. *Proc. Natl. Acad. Sci. U. S. A.* 91, 1781-1785.
- Rodriguez, J.A., Au, W.W.Y., and Henderson, B.R. (2004). Cytoplasmic mislocalization of BRCA1 caused by cancer-associated mutations in the BRCT domain. *Exp. Cell Res.* 293, 14-21.
- Roghi, C., Giet, R., Uzbekov, R., Morin, N., Chartrain, I., Le Guellec, R., Couturier, A., Dorée, M., Philippe, M., and Prigent, C. (1998). The *Xenopus* protein kinase pEg2 associates with the centrosome in a cell cycle-dependent manner, binds to the spindle microtubules and is involved in bipolar mitotic spindle assembly. *J. Cell Sci.* 111 (Pt 5), 557-572.
- Rush, G.F., Gorski, J.R., Ripple, M.G., Sowinski, J., Bugelski, P., and Hewitt, W.R. (1985). Organic hydroperoxide-induced lipid peroxidation and cell death in isolated hepatocytes. *Toxicol. Appl. Pharmacol.* 78, 473-483.
- Sancar, A., Lindsey-Boltz, L.A., Unsal-Kaçmaz, K., and Linn, S. (2004). Molecular mechanisms of mammalian DNA repair and the DNA damage checkpoints. *Annu. Rev. Biochem.* 73, 39-85.
- Sankaran, S., Starita, L.M., Groen, A.C., Ko, M.J., and Parvin, J.D. (2005). Centrosomal microtubule nucleation activity is inhibited by BRCA1-dependent ubiquitination. *Mol. Cell. Biol.* 25, 8656-8668.
- Sankaran, S., Starita, L.M., Simons, A.M., and Parvin, J.D. (2006). Identification of domains of BRCA1 critical for the ubiquitin-dependent inhibition of centrosome function. *Cancer Res.* 66, 4100-4107.
- Sankaran, S., Crone, D.E., Palazzo, R.E., and Parvin, J.D. (2007). BRCA1 regulates gamma-tubulin binding to centrosomes. *Cancer Biol. Ther.* 6, 1853-1857.
- Sartori, A.A., Lukas, C., Coates, J., Mistrik, M., Fu, S., Bartek, J., Baer, R., Lukas, J., and Jackson, S.P. (2007). Human CtIP promotes DNA end resection. *Nature* 450, 509-514.
- Savatier, P., Lapillonne, H., Jirmanova, L., Vitelli, L., and Samarut, J. (2002). Analysis of the cell cycle in mouse embryonic stem cells. *Methods Mol. Biol. Clifton NJ* 185, 27-33.

Schlegel, B.P., Starita, L.M., and Parvin, J.D. (2003). Overexpression of a protein fragment of RNA helicase A causes inhibition of endogenous BRCA1 function and defects in ploidy and cytokinesis in mammary epithelial cells. *Oncogene* 22, 983-991.

Shabbeer, S., Omer, D., Berneman, D., Weitzman, O., Alpaugh, A., Pietraszkiwicz, A., Metsuyanin, S., Shainskaya, A., Papa, M.Z., and Yarden, R.I. (2012). BRCA1 targets G2/M cell cycle proteins for ubiquitination and proteasomal degradation. *Oncogene*.

Shen, K.C., Heng, H., Wang, Y., Lu, S., Liu, G., Deng, C.-X., Brooks, S.C., and Wang, Y.A. (2005). ATM and p21 Cooperate to Suppress Aneuploidy and Subsequent Tumor Development. *Cancer Res.* 65, 8747-8753.

Sherman, M.I. (1975). The culture of cells derived from mouse blastocysts. *Cell* 5, 343-349.

Shiloh, Y., and Ziv, Y. (2013). The ATM protein kinase: regulating the cellular response to genotoxic stress, and more. *Nat. Rev. Mol. Cell Biol.* 14, 197-210.

Skaar, J.R., and Pagano, M. (2009). Control of cell growth by the SCF and APC/C ubiquitin ligases. *Curr. Opin. Cell Biol.* 21, 816-824.

Smith, J., Tho, L.M., Xu, N., and Gillespie, D.A. (2010). The ATM-Chk2 and ATR-Chk1 pathways in DNA damage signaling and cancer. *Adv. Cancer Res.* 108, 73-112.

So, S., Davis, A.J., and Chen, D.J. (2009). Autophosphorylation at serine 1981 stabilizes ATM at DNA damage sites. *J. Cell Biol.* 187, 977-990.

Sobhian, B., Shao, G., Lilli, D.R., Culhane, A.C., Moreau, L.A., Xia, B., Livingston, D.M., and Greenberg, R.A. (2007). RAP80 targets BRCA1 to specific ubiquitin structures at DNA damage sites. *Science* 316, 1198-1202.

Sohn, S.Y., and Cho, Y. (2009). Crystal structure of the human rad9-hus1-rad1 clamp. *J. Mol. Biol.* 390, 490-502.

Solter, D., and Knowles, B.B. (1975). Immunosurgery of mouse blastocyst. *Proc. Natl. Acad. Sci. U. S. A.* 72, 5099-5102.

Song, G., Ouyang, G., and Bao, S. (2005). The activation of Akt/PKB signaling pathway and cell survival. *J. Cell. Mol. Med.* 9, 59-71.

Soutoglou, E., and Misteli, T. (2008). Activation of the cellular DNA damage response in the absence of DNA lesions. *Science* 320, 1507-1510.

De Souza, C.P., Ellem, K.A., and Gabrielli, B.G. (2000). Centrosomal and cytoplasmic Cdc2/cyclin B1 activation precedes nuclear mitotic events. *Exp. Cell Res.* 257, 11-21.

Stadtfield, M., Nagaya, M., Utikal, J., Weir, G., and Hochedlinger, K. (2008). Induced pluripotent stem cells generated without viral integration. *Science* 322, 945-949.

Starita, L.M., Machida, Y., Sankaran, S., Elias, J.E., Griffin, K., Schlegel, B.P., Gygi, S.P., and Parvin, J.D. (2004). BRCA1-Dependent Ubiquitination of γ -Tubulin Regulates Centrosome Number. *Mol. Cell. Biol.* 24, 8457-8466.

Stover, A.E., Brick, D.J., Nethercott, H.E., Banuelos, M.G., Sun, L., O'Dowd, D.K., and Schwartz, P.H. (2013). Process-based expansion and neural differentiation of human pluripotent stem cells for transplantation and disease modeling. *J. Neurosci. Res.* 91, 1247-1262.

Suemori, H., Yasuchika, K., Hasegawa, K., Fujioka, T., Tsuneyoshi, N., and Nakatsuji, N. (2006). Efficient establishment of human embryonic stem cell lines and long-term maintenance with stable karyotype by enzymatic bulk passage. *Biochem. Biophys. Res. Commun.* 345, 926-932.

Syljuåsen, R.G., Jensen, S., Bartek, J., and Lukas, J. (2006). Adaptation to the ionizing radiation-induced G2 checkpoint occurs in human cells and depends on checkpoint kinase 1 and Polo-like kinase 1 kinases. *Cancer Res.* 66, 10253-10257.

Tada, M., Takahama, Y., Abe, K., Nakatsuji, N., and Tada, T. (2001). Nuclear reprogramming of somatic cells by in vitro hybridization with ES cells. *Curr. Biol.* CB 11, 1553-1558.

Takahashi, K., and Yamanaka, S. (2006). Induction of pluripotent stem cells from mouse embryonic and adult fibroblast cultures by defined factors. *Cell* 126, 663-676.

Takahashi, K., Tanabe, K., Ohnuki, M., Narita, M., Ichisaka, T., Tomoda, K., and Yamanaka, S. (2007). Induction of pluripotent

stem cells from adult human fibroblasts by defined factors. *Cell* 131, 861-872.

Takai, H., Tominaga, K., Motoyama, N., Minamishima, Y.A., Nagahama, H., Tsukiyama, T., Ikeda, K., Nakayama, K., Nakanishi, M., and Nakayama, K. (2000). Aberrant cell cycle checkpoint function and early embryonic death in *Chk1(-/-)* mice. *Genes Dev.* 14, 1439-1447.

Takemura, H., Rao, V.A., Sordet, O., Furuta, T., Miao, Z.-H., Meng, L., Zhang, H., and Pommier, Y. (2006). Defective Mre11-dependent activation of Chk2 by ataxia telangiectasia mutated in colorectal carcinoma cells in response to replication-dependent DNA double strand breaks. *J. Biol. Chem.* 281, 30814-30823.

Tanaka, M., Ueda, A., Kanamori, H., Ideguchi, H., Yang, J., Kitajima, S., and Ishigatsubo, Y. (2002). Cell-cycle-dependent Regulation of Human aurora A Transcription Is Mediated by Periodic Repression of E4TF1. *J. Biol. Chem.* 277, 10719-10726.

Tatsuka, M., Sato, S., Kitajima, S., Suto, S., Kawai, H., Miyauchi, M., Ogawa, I., Maeda, M., Ota, T., and Takata, T. (2005). Overexpression of Aurora-A potentiates HRAS-mediated oncogenic transformation and is implicated in oral carcinogenesis. *Oncogene* 24, 1122-1127.

Tauer, C.A. (1997). Embryo research and public policy: a philosopher's appraisal. *J. Med. Philos.* 22, 423-439.

Thomson, J.A., Kalishman, J., Golos, T.G., Durning, M., Harris, C.P., Becker, R.A., and Hearn, J.P. (1995). Isolation of a primate embryonic stem cell line. *Proc. Natl. Acad. Sci. U. S. A.* 92, 7844-7848.

Thomson, J.A., Itskovitz-Eldor, J., Shapiro, S.S., Waknitz, M.A., Swiergiel, J.J., Marshall, V.S., and Jones, J.M. (1998). Embryonic stem cell lines derived from human blastocysts. *Science* 282, 1145-1147.

Thornton, T.M., and Rincon, M. (2009). Non-classical p38 map kinase functions: cell cycle checkpoints and survival. *Int. J. Biol. Sci.* 5, 44-51.

Tibbetts, R.S., Cortez, D., Brumbaugh, K.M., Scully, R., Livingston, D., Elledge, S.J., and Abraham, R.T. (2000). Functional interactions between BRCA1 and the checkpoint kinase ATR during genotoxic stress. *Genes Dev.* 14, 2989-3002.

Tichy, E.D. (2011). Mechanisms maintaining genomic integrity in embryonic stem cells and induced pluripotent stem cells. *Exp. Biol. Med.* Maywood NJ 236, 987-996.

Toji, S., Yabuta, N., Hosomi, T., Nishihara, S., Kobayashi, T., Suzuki, S., Tamai, K., and Nojima, H. (2004). The centrosomal protein Lats2 is a phosphorylation target of Aurora-A kinase. *Genes Cells Devoted Mol. Cell. Mech.* 9, 383-397.

Tomimatsu, N., Mukherjee, B., and Burma, S. (2009). Distinct roles of ATR and DNA-PKcs in triggering DNA damage responses in ATM-deficient cells. *EMBO Rep.* 10, 629-635.

Torchia, E.C., Zhang, L., Huebner, A.J., Sen, S., and Roop, D.R. (2013). Aurora kinase-A deficiency during skin development impairs cell division and stratification. *J. Invest. Dermatol.* 133, 78-86.

Vader, G., and Lens, S.M.A. (2008). The Aurora kinase family in cell division and cancer. *Biochim. Biophys. Acta* 1786, 60-72.

Van Vugt, M.A., Smits, V.A., Klompaker, R., and Medema, R.H. (2001). Inhibition of Polo-like kinase-1 by DNA damage occurs in an ATM- or ATR-dependent fashion. *J. Biol. Chem.* 276, 41656-41660.

Wang, J.C. (2002). Cellular roles of DNA topoisomerases: a molecular perspective. *Nat. Rev. Mol. Cell Biol.* 3, 430-440.

Wang, B., Matsuoka, S., Ballif, B.A., Zhang, D., Smogorzewska, A., Gygi, S.P., and Elledge, S.J. (2007). Abraxas and RAP80 form a BRCA1 protein complex required for the DNA damage response. *Science* 316, 1194-1198.

Wang, X., Lui, V.C., Poon, R.T., Lu, P., and Poon, R.Y. (2009). DNA Damage Mediated S and G2 Checkpoints in Human Embryonal Carcinoma Cells. *Stem Cells Dayt. Ohio* 27, 568-576.

Warren, L., Manos, P.D., Ahfeldt, T., Loh, Y.-H., Li, H., Lau, F., Ebina, W., Mandal, P.K., Smith, Z.D., Meissner, A., et al. (2010). Highly efficient reprogramming to pluripotency and directed differentiation of human cells with synthetic modified mRNA. *Cell Stem Cell* 7, 618-630.

Werbowski-Ogilvie, T.E., Bossé, M., Stewart, M., Schnerch, A., Ramos-Mejia, V., Rouleau, A., Wynder, T., Smith, M.-J., Dingwall, S., Carter, T., et al. (2009). Characterization of

human embryonic stem cells with features of neoplastic progression. *Nat. Biotechnol.* 27, 91-97.

Wernig, M., Lengner, C.J., Hanna, J., Lodato, M.A., Steine, E., Foreman, R., Staerk, J., Markoulaki, S., and Jaenisch, R. (2008). A drug-inducible transgenic system for direct reprogramming of multiple somatic cell types. *Nat. Biotechnol.* 26, 916-924.

Wertz, D.C. (2002). Embryo and stem cell research in the USA: a political history. *Trends Mol. Med.* 8, 143-146.

White, J.S., Choi, S., and Bakkenist, C.J. (2010). Transient ATM kinase inhibition disrupts DNA damage-induced sister chromatid exchange. *Sci. Signal.* 3, ra44.

Wilmot, I., Schnieke, A.E., McWhir, J., Kind, A.J., and Campbell, K.H. (1997). Viable offspring derived from fetal and adult mammalian cells. *Nature* 385, 810-813.

Wilsker, D., Petermann, E., Helleday, T., and Bunz, F. (2008). Essential function of Chk1 can be uncoupled from DNA damage checkpoint and replication control. *Proc. Natl. Acad. Sci. U. S. A.* 105, 20752-20757.

Wilton, L. (2002). Preimplantation genetic diagnosis for aneuploidy screening in early human embryos: a review. *Prenat. Diagn.* 22, 512-518.

Wu, L.C., Wang, Z.W., Tsan, J.T., Spillman, M.A., Phung, A., Xu, X.L., Yang, M.C., Hwang, L.Y., Bowcock, A.M., and Baer, R. (1996). Identification of a RING protein that can interact in vivo with the BRCA1 gene product. *Nat. Genet.* 14, 430-440.

Wu-Baer, F., Lagrizon, K., Yuan, W., and Baer, R. (2003). The BRCA1/BARD1 heterodimer assembles polyubiquitin chains through an unconventional linkage involving lysine residue K6 of ubiquitin. *J. Biol. Chem.* 278, 34743-34746.

Xu, B., Kim St, and Kastan, M.B. (2001). Involvement of Brcal in S-phase and G(2)-phase checkpoints after ionizing irradiation. *Mol. Cell. Biol.* 21, 3445-3450.

Xu, B., O'Donnell, A.H., Kim, S.-T., and Kastan, M.B. (2002). Phosphorylation of serine 1387 in Brcal is specifically required for the Atm-mediated S-phase checkpoint after ionizing irradiation. *Cancer Res.* 62, 4588-4591.

Xu, M., Bai, L., Gong, Y., Xie, W., Hang, H., and Jiang, T. (2009). Structure and functional implications of the human rad9-hus1-rad1 cell cycle checkpoint complex. *J. Biol. Chem.* 284, 20457-20461.

Xu, X., Weaver, Z., Linke, S.P., Li, C., Gotay, J., Wang, X.W., Harris, C.C., Ried, T., and Deng, C.X. (1999). Centrosome amplification and a defective G2-M cell cycle checkpoint induce genetic instability in BRCA1 exon 11 isoform-deficient cells. *Mol. Cell* 3, 389-395.

Yamanaka, S. (2007). Strategies and new developments in the generation of patient-specific pluripotent stem cells. *Cell Stem Cell* 1, 39-49.

Yan, J., Kim, Y.-S., Yang, X.-P., Li, L.-P., Liao, G., Xia, F., and Jetten, A.M. (2007). The ubiquitin-interacting motif containing protein RAP80 interacts with BRCA1 and functions in DNA damage repair response. *Cancer Res.* 67, 6647-6656.

Yang, C., Tang, X., Guo, X., Niikura, Y., Kitagawa, K., Cui, K., Wong, S.T.C., Fu, L., and Xu, B. (2011). Aurora-B Mediated ATM Serine 1403 Phosphorylation Is Required for Mitotic ATM Activation and the Spindle Checkpoint. *Mol. Cell* 44, 597-608.

Yarden, R.I., Pardo-Reoyo, S., Sgagias, M., Cowan, K.H., and Brody, L.C. (2002). BRCA1 regulates the G2/M checkpoint by activating Chk1 kinase upon DNA damage. *Nat. Genet.* 30, 285-289.

Yarden, R.I., Metsuyanin, S., Pickholtz, I., Shabbeer, S., Tellio, H., and Papa, M.Z. (2012). BRCA1-dependent Chk1 phosphorylation triggers partial chromatin disassociation of phosphorylated Chk1 and facilitates S-phase cell cycle arrest. *Int. J. Biochem. Cell Biol.* 44, 1761-1769.

Yoon, Y., Cowley, D.O., Gallant, J., Jones, S.N., Van Dyke, T., and Rivera-Pérez, J.A. (2012). Conditional Aurora A deficiency differentially affects early mouse embryo patterning. *Dev. Biol.* 371, 77-85.

You, Z., Bailis, J.M., Johnson, S.A., Dilworth, S.M., and Hunter, T. (2007). Rapid activation of ATM on DNA flanking double-strand breaks. *Nat. Cell Biol.* 9, 1311-1318.

Yu, X., and Chen, J. (2004). DNA damage-induced cell cycle checkpoint control requires CtIP, a phosphorylation-dependent binding partner of BRCA1 C-terminal domains. *Mol. Cell. Biol.* 24, 9478-9486.

Yu, J., Vodyanik, M.A., Smuga-Otto, K., Antosiewicz-Bourget, J., Frane, J.L., Tian, S., Nie, J., Jonsdottir, G.A., Ruotti, V., Stewart, R., et al. (2007). Induced pluripotent stem cell lines derived from human somatic cells. *Science* 318, 1917-1920.

Yu, J., Hu, K., Smuga-Otto, K., Tian, S., Stewart, R., Slukvin, I.I., and Thomson, J.A. (2009). Human induced pluripotent stem cells free of vector and transgene sequences. *Science* 324, 797-801.

Yu, X., Chini, C.C.S., He, M., Mer, G., and Chen, J. (2003). The BRCT domain is a phospho-protein binding domain. *Science* 302, 639-642.

Yu, X., Fu, S., Lai, M., Baer, R., and Chen, J. (2006). BRCA1 ubiquitinates its phosphorylation-dependent binding partner CtIP. *Genes Dev.* 20, 1721-1726.

Von Zglinicki, T., Pilger, R., and Sitte, N. (2000). Accumulation of single-strand breaks is the major cause of telomere shortening in human fibroblasts. *Free Radic. Biol. Med.* 28, 64-74.

Zhang, C., Liu, Y., Hu, Z., An, L., He, Y., and Hang, H. (2011). Targeted deletion of mouse Rad1 leads to deficient cellular DNA damage responses. *Protein Cell* 2, 410-422.

Zhang, H., Somasundaram, K., Peng, Y., Tian, H., Zhang, H., Bi, D., Weber, B.L., and El-Deiry, W.S. (1998). BRCA1 physically associates with p53 and stimulates its transcriptional activity. *Oncogene* 16, 1713-1721.

Zhao, T., Zhang, Z.-N., Rong, Z., and Xu, Y. (2011). Immunogenicity of induced pluripotent stem cells. *Nature* 474, 212-215.

Zhou, H., Kuang, J., Zhong, L., Kuo, W.L., Gray, J.W., Sahin, A., Brinkley, B.R., and Sen, S. (1998). Tumour amplified kinase STK15/BTAK induces centrosome amplification, aneuploidy and transformation. *Nat. Genet.* 20, 189-193.

Zhou, H., Wu, S., Joo, J.Y., Zhu, S., Han, D.W., Lin, T., Trauger, S., Bien, G., Yao, S., Zhu, Y., et al. (2009). Generation of induced pluripotent stem cells using recombinant proteins. *Cell Stem Cell* 4, 381-384.

Vita

Jason Mark Beckta was born on October 5th, 1986 in Keene, New Hampshire. He graduated Keene High School in 2005, and received his Bachelor of Science degree from Keene State College in 2008.

He matriculated into the M.D.-Ph.D. program at Virginia Commonwealth University in June of 2008. After completing the first two years of medical school, Jason joined Dr. Kristoffer Valerie's lab in July of 2010. At the time of this writing, Jason lives in Richmond, Virginia, with his wife Julie, two dogs, and a three-legged cat named Gregory.

EDUCATION

M.D.-Ph.D., anticipated May 2016
Virginia Commonwealth University School of Medicine, Richmond VA
(in the tradition of the Medical College of Virginia)

B.S. in Behavioral Biology, Summa Cum Laude, May 2008
Keene State College, Keene, New Hampshire

PUBLICATIONS

ATM Kinase Inhibition Preferentially Sensitizes p53-Mutant Glioma to Ionizing Radiation. Biddlestone-Thorpe L, Sajjad M, Rosenberg E, **Beckta JM**, Valerie NC, Tokarz M, Adams BR, Wagner AF, Khalil A, Gilfor D, Golding SE, Deb S, Temesi DG, Lau A, O'Connor MJ, Choe KS, Parada LF, Lim SK, Mukhopadhyay ND, Valerie K.

Clin Cancer Res. 2013 May 17. PMID: 23620409

Two- and three-dimensional live cell imaging of DNA damage response proteins.

Beckta JM, Henderson SC, Valerie K.

J Vis Exp. 2012 Sep 28;(67). doi:pii: 4251. 10.3791/4251. PMID: 23052275

Synthesis of water-soluble camptothecin-polyoxetane conjugates via click chemistry.

Zolotarskaya OY, Wagner AF, **Beckta JM**, Valerie K, Wynne KJ, Yang H.

Mol Pharm. 2012 Nov 5;9(11):3403-8. doi: 10.1021/mp3005066. PMID: 23051100

Dynamic inhibition of ATM kinase provides a strategy for glioblastoma multiforme radiosensitization and growth control.

Golding SE, Rosenberg E, Adams BR, Wignarajah S, **Beckta JM**, O'Connor MJ, Valerie K.

Cell Cycle. 2012 Mar 15;11(6):1167-73. doi: 10.4161/cc.11.6.19576. PMID: 22370485

PUBLICATIONS (CONT.)

In Vivo and In Vitro Human Brain Tumor Models for Improving the Therapeutic Ratio of Ionizing Radiation and DNA Repair Inhibitors.

Adams, B., Golding, S., Biddlestone-Thorpe, L., **Beckta, J.**, Saleh, H., Enikopolov, G., & Valerie, K.

Int. J. Radiat. Oncol. Biol. Phys. **81**, S741-S742 (2011). ISSN 0360-3016

SCHOLARSHIPS AND HONORS

- 12-15 National Cancer Institute F30 Fellowship:
ATM Controls Genomic Stability in Pluripotent Stem Cells
- 2011 M2 Course Award (highest grade in course): Renal
- 2011 M2 Course Award (highest grade in course): Cardiology
- 10-11 Alpha Omega Alpha Honor Medical Society
- 2008 Dean's Scholarship MCV
- 2008 National Society of Collegiate Scholars
- 05-08 Dean's List (all semesters)
- 06-07 Winnona V. Hubbard Scholarship
- 2006 Keene State College Undergraduate Research Grant:
Effects of the Pesticides Bifenthrin and Glyphosate on Development in the Amphibian *Xenopus laevis*
- 2005 Keene State College Enrichment Scholarship
- 2005 Keene Police Officers Scholarship